

National Aeronautics and  
Space Administration

Educational Product

Teachers

Grades K-4

# OUR MISSION TO PLANET EARTH



## A Guide to Teaching Earth System Science



*Our Mission to Planet Earth—A Guide to Teaching Earth System Science* is available in electronic format through NASA Spacelink—one of the Agency's electronic resources specifically developed for use by the educational community.

The system may be accessed at the following address:  
<http://spacelink.nasa.gov>

# OUR MISSION TO PLANET EARTH

---

## A Guide to Teaching Earth System Science

---

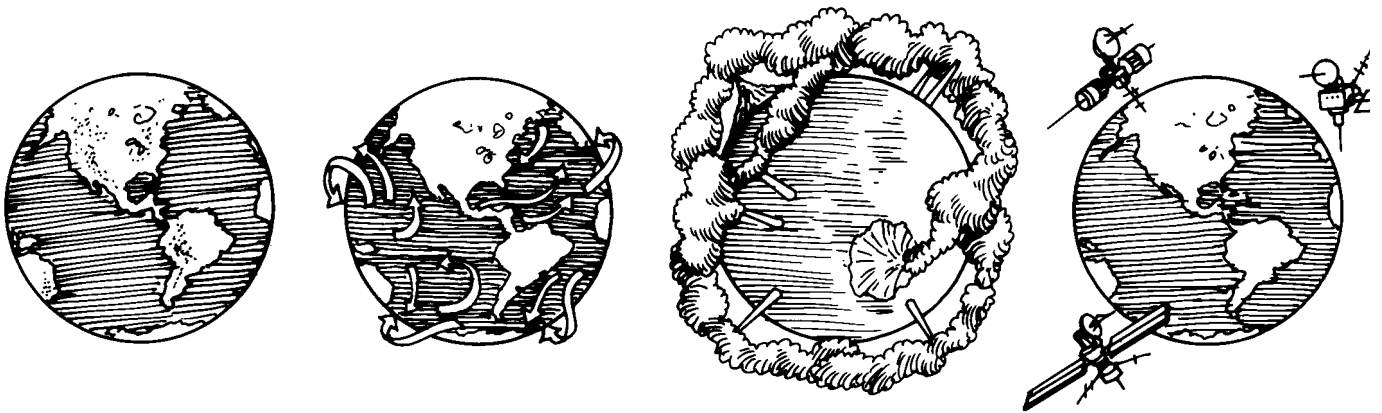

National Aeronautics and Space Administration  
Office of Mission to Planet Earth  
Office of Human Resources and Education  
Education Division

This publication is in the Public Domain and is not protected by copyright. Permission is not required for duplication.

---

# Acknowledgments

---

NASA wishes to express its deep appreciation and gratitude to the teachers who helped in reviewing and developing "Our Mission to Planet Earth."

Julia Berry  
St. Patrick's Episcopal School  
Washington, DC

Elizabeth Fucella Burgos  
Abingdon Elementary School  
Arlington, VA

Shelley Novaco  
Ridgecrest Elementary School  
Chillum, MD

Don Petersen  
Willow Springs School  
Fairfax, VA

Margaret Longo  
Mill Creek Towne Elementary School  
Derwood, MD

Irene Morris  
Stevens Elementary School  
Washington, DC

---

# Table of Contents

---

<b>Introduction</b>	A Guide to Teaching Earth System Science .....	1
<b>Unit 1 Earth From Space</b>	Demonstrating the View from Space.....	5
	Energy .....	6
	Creating an Earth System Model .....	7
	Systems .....	8
<b>Unit 2 Forces of Change</b>	Cycles: How Earth's Components Interact within the System .....	11
	Water Cycle.....	12
	Water Cycle Changes .....	14
<b>Unit 3 Global Change</b>	Global Environmental Impacts.....	17
	Land-use Changes: Deserts .....	18
	Greenhouse Effect: Global Warming.....	19
	Global Cooling.....	21
<b>Unit 4 Mission to Planet Earth</b>	Satellites: Observing the Whole Earth .....	23
	Satellites .....	26
	Instruments .....	26
	Satellite Design.....	26
	Data .....	27
	Modeling.....	27
	Careers .....	30
<b>NASA Resources for Educators</b>	.....	33



# OUR MISSION TO PLANET EARTH

---

## A Guide to Teaching Earth System Science

---

### **Introduction**

Volcanic eruptions, hurricanes, floods, and El Niño are naturally occurring events over which humans have no control. But can human activities cause additional environmental change? Can scientists predict the global impacts of increased levels of pollutants in the atmosphere? Will the planet warm because increased levels of greenhouse gases, produced by the burning of fossil fuels, trap heat and prevent it from being radiated back into space? Will the polar ice caps melt, causing massive coastal flooding? Have humans initiated wholesale climatic change?

These are difficult questions, with grave implications. Predicting global change and understanding the relationships among Earth's components have become a priority for the nation. The National Aeronautics and Space Administration (NASA), along with many other government agencies, has initiated long-term studies of Earth's atmosphere, oceans, and land masses using observations from satellite-, balloon-, and aircraft-borne instruments. NASA calls its research program Mission to Planet Earth. Because NASA can place scientific instruments far above Earth's surface, the program allows scientists to explore Earth's components and their interactions on a global scale.

### **Earth as a System**

Although this program will never answer all the questions, NASA realizes that understanding the planet will not happen by examining pieces one at a time; it will take teams of biologists, physicists, chemists, and geologists working together to fully understand Earth as a system. Earth Science, in short, must be an interdisciplinary challenge. The scope of Earth Science is sometimes limited to the study of geology and some closely allied fields, such as oceanography. The Mission to Planet Earth calls for an interdisciplinary approach including biology, chemistry, and physics.

This leads to why NASA initiated the development of “Our Mission to Planet Earth: A Guide to Teaching Earth System Science.” The children in your classrooms today could become the scientists of tomorrow who will analyze the data streaming back to Earth via satellite communications. NASA will look to their generation for talent. Consequently, children’s exposure to the concept of Earth as a system cannot begin too early. Even if your students do not pursue careers in Earth Science, they must understand Earth System Science. They could face the challenge of trying to adapt to global climate change.

## Cycles and Change

This teacher’s guide is not meant to replace the existing curricula of your local school jurisdiction, but rather to augment it. The primary goal is for children to become familiar with the concept of cycles, defined as a process that repeats itself in the same order, and to learn that some human activities can cause changes in their environment.

It is assumed in this guide that children are already studying the basics of Earth Science. They have learned about the planet’s primary components—its land, air, and water, and understand the role of the Sun in providing us with energy. Although the guide addresses Earth’s components, it does so from the perspective of space to show the planet as a large system, with interacting parts. To demonstrate on a much smaller scale how these parts work together, children are asked to build their own Earth system, a terrarium, which will be used for experimentation throughout the guide. For instance, your students observe how water evaporates due to the Sun’s radiation and eventually condenses to form clouds. They are exposed to the relationship between land and water, and the topographical changes due to erosion. Through experimentation with the terrarium, they learn about the impact of global change on the system.

After completing these lessons, they learn how scientists use satellite technology to examine the entire planet as a whole to study global climate—the basics of NASA’s Mission to Planet Earth program. They create their own models of instruments and satellites and learn about careers in Earth System Science. Although some younger children may understand these concepts, the activities are geared primarily to second and third graders. For kindergarten and first grade teachers, however, this should not preclude you from incorporating some of the activities into your lessons.

## **Tomorrow's Scientists, Engineers, and Technicians**

“Our Mission to Planet Earth” is designed to reinforce basic skills. Through hands-on activities, experiments, and discussions, students practice how to identify, classify, organize, and recall information. They become familiar with new vocabulary. You are encouraged to create any type of scenario—pretending, for instance, that students are Earth scientists—to make the lessons come to life. Above all, the program is aimed at allowing younger people to recognize themselves as part of the Earth system.

For NASA, the challenge has been to develop a package that makes integrated Earth Science compelling, understandable, and interesting to young minds. NASA has a vested interest. The agency, after all, is depending on your students to become the engineers, scientists, and technicians of tomorrow, those who will build the next generation of satellites or interpret the data and inform leaders of responsible environmental policies. While many of your students will pursue other roles in society, an understanding of the Earth system is still important. They could face the more daunting, long-term challenge of trying to control or adapt to global climate change.

Our Mission to Planet Earth includes a teacher's guide and a set of seven lithographs designed to illustrate key lessons in the package. Although NASA has recommended specific lithographs for each unit (see “Visuals” selection of each unit), you may use other visuals to augment the lessons. Photographs found in magazines, newspapers and other sources work well, as do posters and slides.





# EARTH FROM SPACE



Unit 1

---

## Demonstrating the View from Space

---

### Introduction

Photographs of Earth taken from space show that our planet is a single system. When students observe Earth from this perspective, they can readily see oceans, clouds, and continents that are lit by sunlight, the energy that supports life on Earth. We do not know of any other planet that has water and an atmosphere like Earth's. (However, the components alone—solids, liquids, gases—without continuous changes in temperature, composition, and chemistry, might not support life as we know it.) To understand the way the Earth system works, students first must learn what these components are and then examine ways that they interact and change. To do this, they will build terrariums as models of Earth. Throughout these four units, students will learn how scientists study Earth's system to understand human-induced and natural changes.

### Objectives

Students will be able to:

- Identify in photographs Earth's components from space: water (oceans, bays, rivers), land (continents), and air (atmosphere).
- Find the atmosphere in a photograph showing the limb (curved edge) of Earth.
- Identify the Sun as the source of energy and life on Earth.
- Recognize that different-colored components absorb and reflect sunlight differently.

### Visuals

- NASA Lithograph: View of Earth
- NASA Lithograph: Water is a Force of Change
- NASA Lithograph: TOPEX/Poseidon. Photo of Earth limb from space showing Earth's atmosphere.

## Vocabulary

Absorb	Heat	River
Atmosphere	Land	Soil
Cloud	Ocean	Sunlight
Continent	Oxygen	Surface
Earth	Reflect	Terrarium

## Activities

Demonstrating the View from Space.

Films, videos, and photos: Show aerial and space views of Earth to help students understand that the air, land, and water seen in the photo are the same as those seen from the ground; they just are seen from a different perspective. Ask students who have flown in airplanes or climbed to the top of tall mountains to describe what they saw. Point to the U.S. in the photo of Earth from Space. If they are not familiar with the U.S. map, explain that large areas of land are visible from space and that it would take many hours to drive by car from one area to another. Use common local trips to help your students relate to distances.



## Energy

The Sun's radiation is the source of energy for the Earth system. The heat and light allow plants and animals to thrive. The radiation also supplies the energy for many of the cycles among the atmosphere, oceans, and land. Air, land, and water absorb or reflect energy differently, affecting weather patterns, ocean currents, winds, and temperatures. Deserts and clouds reflect a great deal of energy, while ocean surfaces and forests reflect less. The warming of Earth's atmosphere moderates the temperatures around the globe making it inhabitable by living things.

**Materials**

White sand, black potting soil, and light grey gravel, three thermometers, three clear glass bowls. (Many heat-resistant, hard, fine-grained potting materials could work.) Be sure to use one white and one black for contrast in absorption of energy.

**Observation**

Demonstrating Absorption of Solar Energy.

To demonstrate the effects of solar energy on our planet, students must learn that components of the Earth system absorb sunlight differently. Place sand, gravel, and soil in each of the three glass bowls and insert one of the thermometers just below the surface of each material. Leave the containers in sunlight for several hours. White sand represents the clouds and snow; black soil, the land (forest, green grass); and grey, the ocean or dead grass. Ask the students to compare the temperatures to see how the differently colored materials absorb heat.

**Extra Activity**

Under which materials would you put ice if you wanted it to melt faster? Try it.

Lighter colors reflect more light (stay cooler); darker colors absorb more light (get warmer). Clean white surfaces, like snow, reflect about 90% of the light hitting them. City snow-removal crews could put dark soil on piles of snow when they want the snow to melt faster.

---

## Creating an Earth System Model

---

**Introduction**

Students should build a small Earth environment to understand that the components fit together, and that they interact and change. Students may create a terrarium using animals and plants. Include a pond in the terrarium. The terrarium could show land, air, water, and energy. The easiest method to control the conditions during the experiments found in the next two lessons is to build one large group terrarium and several small ones (up to six). Some students may choose to pick a particular environment. One student team might work with sandy soil and cactuses, for example, and another might fill an aquarium with tadpoles and pond plants.

## Materials

Terrarium. Potting soil, gravel, activated charcoal, sand, clay, rocks, and small plants. Rectangular glass tank, watering can with a thermometer inside. Small glass bowl to sink in the soil as a pond. Small plastic toys loaned by the students. Optional occupants: salamanders, newts, turtles, insects, frogs, or fish. (Fish will die in a little bowl; each one requires at least one gallon of water, which needs to be changed regularly.) Laws govern the capture and handling of wildlife, so check with your state, city, or federal authorities. Several of these animals can be purchased from pet stores for as little as five dollars.

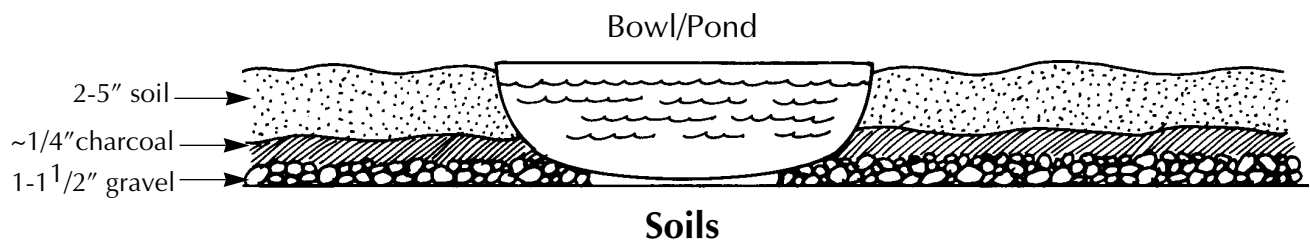

## Vocabulary

Aquarium

System

Terrarium

## Systems

A "system" is a group of elements that interact and function together as a whole. To help students understand the complexity of a "system," discuss other systems found in their immediate environment. School, neighborhoods, families, and local public transportation services all can be classified as systems. Second, to help students recognize the impact of change, ask students whether those systems ever malfunctioned. Was the bus late? Do large snowstorms sometimes close school? Tell them that to understand how the system works, they are going to construct their own model of an Earth system. Later, when all the components are in the terrariums, the students can conduct experiments to observe how the components interact with each other.

## Activity

How to building the model Earth system, with several approaches to construction. Students should build an unsealed terrarium (open system) unless the teacher has experience with closed-system terrariums.

## Observation

Terrariums or aquariums would work best in a class that has time to watch living things grow. A version built by the whole group might be better suited to K and Grade 1, while team or individually built versions would work well for Grades 2 or 3. To conduct the terrarium experiments found throughout the guide, classes will need at least six jar-size terrariums. **Do not use terrariums containing live animals in any of the experiments. Some of the experiments could harm the animals.**

Terrarium: Part 1, Setting up the Terrariums.

(A follow-up to this experiment will be conducted in subsequent lessons.)

Use one of the terrariums or separate containers. Set up an experiment monitoring plant growth and plant appearance in which frequency of watering, water temperature, exposure to fresh air, soil, and light at the start are as constant as possible. Select plants with different light or water requirements and establish if they thrive under these starting conditions. Select rapid-growing grasses or flowers and slow-growing cactuses, succulents, ferns, etc. Note their condition and growth on a chart (see model, page 10) or in notebooks. Later, students will experiment with the terrariums by altering one of the components, either exposure to light or frequency of watering, to see how changes affect the various types of plants. To teach the activity as a more controlled experiment, set up two identical containers for each plant variety. Allow a few days for them to stabilize, then use one as the control and one as the experimental mini-terrarium.

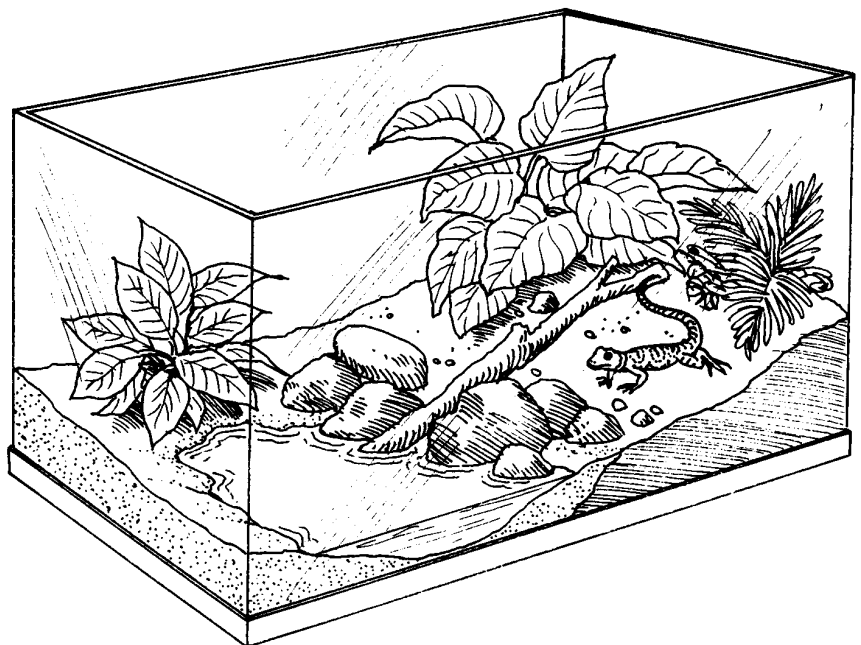

# Terrarium Observation Chart

Type of Plant

Type of Plant				
Soil Type				
Room Temperature				
Frequency of Watering				
Hours of Light Exposure				

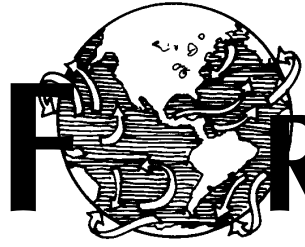

# FORCES OF CHANGE

---

## Cycles: How Earth's Components Interact within the System

---

### Introduction

A demonstration of the water cycle using a terrarium is an ideal model for your class to observe changes that occur in the Earth system. Looking at the whole planet, cycles include events occurring over very large areas and long periods of time, so they are difficult to see from the surface. In the “model Earth,” events can cause immediate and dramatic changes. The next two units use the water cycle and the effects of erosion and drought to demonstrate the principle of cycles in the Earth system.

Cycles, like the seasons, are a natural occurrence on Earth. Earth's cycles provide a balance to which people and nature have adapted. The water cycle spreads life-giving water and minerals within local regions and around the world.

### Objectives

Students will be able to:

- Recognize that because air, land, and water absorb and reflect sunlight differently, they all affect the water cycle.
- Document in a notebook or on a group-produced chart a “scientific investigation” using the terrarium. Observe, measure, and make predictions about changes to the components of the terrariums.
- Name the parts of a water cycle on Earth and in the terrarium: water, evaporation by the Sun, clouds, rain or snow (precipitation), rivers, lakes, oceans and ice, etc.
- Describe what happens to the soil and the plants in the terrarium when they have too much water (flood).
- Predict how too much rain might affect soils and plants on Earth.
- Describe what happens to the soil and the plants when they get sunlight but too little water (drought).



## Visuals

NASA Lithograph: Water is a Force of Change

## Vocabulary

Cycles

Erosion

Moisture

Dissolve

Evaporation

Precipitation

Drought

Global Change

Water Cycle

## Water Cycle

A cycle is a sequence of events that repeats itself, such as the seasonal cycle: summer, fall, winter, and spring. In the Earth system, the same components interact repeatedly; the water cycle is a good example. Sunlight evaporates water; the moisture rises into the atmosphere, where it condenses as clouds. When the warm, moisture-laden clouds meet colder air, the temperature drop makes the water vapor precipitate and fall to Earth as rain or snow. On land, water soaks into the ground or flows to the oceans and lakes by streams and rivers. This water is redistributed across Earth as water vapor, clouds, and rivers or snow and ice.

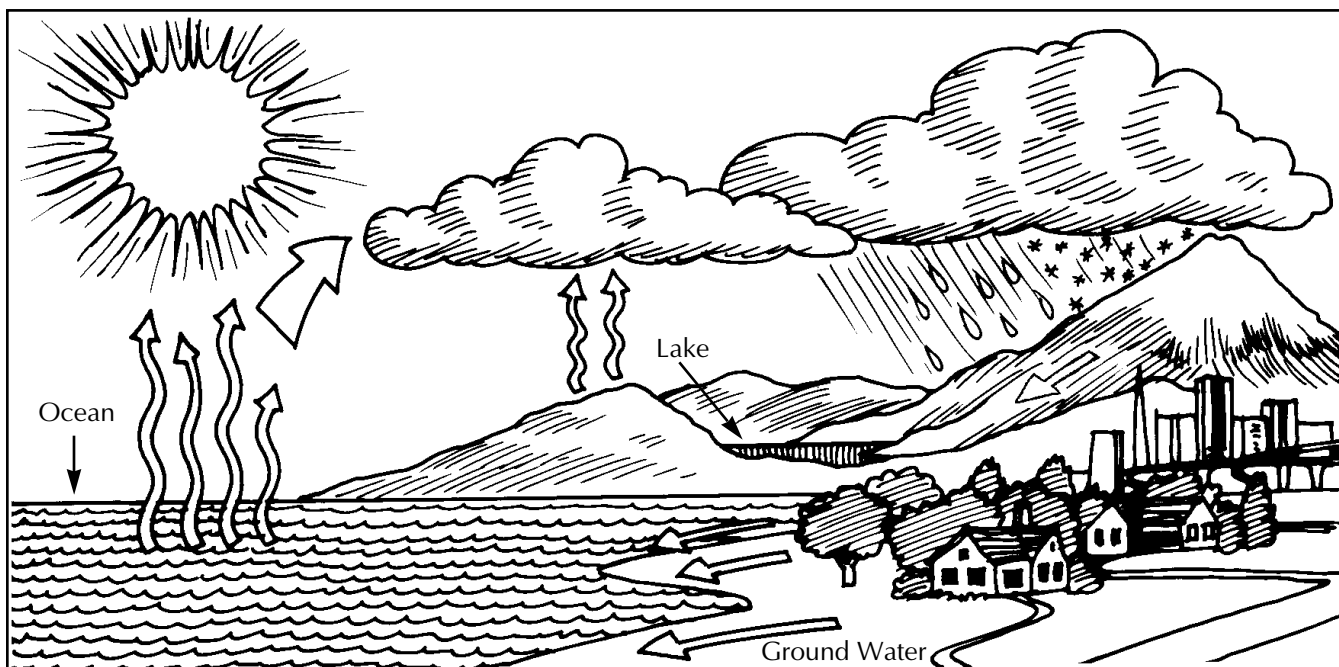

**Activities** Demonstrating the Water Cycle.

**Materials** Glass or plastic to cover the terrarium, bowl or mirror, wet towel, household iron.

**Observations** Terrarium: Part 2, Demonstrating the Water Cycle: Catch a Cloud.

Cover the terrarium and observe how moisture collects on the glass and drips down the sides of the terrarium. Ask the students to guess why this happens. You can also generate water vapor by ironing a towel or boiling water in a covered pot. Either can represent the Sun heating Earth. Hold a glass bowl or large mirror over the rising steam and “catch a cloud.”

Demonstrating Evaporation.

Demonstrate evaporation of water from a puddle. On a sunny day, pour a cup of water on the sidewalk. Have students draw a circle around the perimeter with chalk. Tell them to come back in 30 minutes to see the puddle. Create a smaller puddle indoors by putting drops of water on a baking sheet. Use a hair dryer on the puddle to represent a warm, windy day when the Sun is shining. Ask them where the water went and why.

Terrarium as a System.

Record information about the terrarium experiment on a wall chart or in individual notebooks. Draw pictures of the different plant species both before and after conditions are changed.

Terrarium: Part 3, Changes to the System.

Continue to track the conditions of the plants in a terrarium. To make the terrarium climate more like Earth’s, change one of the conditions (either provide more or less water or reduce or increase the exposure to light). Monitor each of the plants’ growth under this new condition. Students should note all changes to the plants and how much water and sunlight they received. Plants grow long and weak and lose some of their color if they need more light, or they wilt and dry out when they need more water.

## Water Cycle Changes

Living things are highly dependent on the water cycle. Some creatures living in lakes, rivers, or streams will be affected if water levels rise or fall. Too little rain, which results in a drought, can weaken or kill plants, thus reducing food for animals. People and animals can migrate to food and water, but if the drought continues or spreads, eventually they will die.

Too much snow or rain, on the other hand, can drown plants or create floods that wash away land (plant and animal habitats) and flush pesticides and industrial chemicals into rivers. With flooding, erosion sometimes occurs. While erosion is a natural process, careless practices by humans can cause loss of valuable topsoil and contribute to the spreading of deserts in the world.

### Observation

Terrarium: Part 4, Demonstrating Erosion.

Use the terrarium as a model of Earth to demonstrate how water can carry materials from one place to another through erosion of soils or dissolution of minerals.

### Materials

One of the terrariums, or empty jar and soil; source of tap water; bag of salt; paper cups.

### Mixing

Demonstrate by pouring water onto the terrarium soil how land erodes and destroys vegetation. The water will wash soil into the terrarium pond and make it cloudy. Particles of dirt, sand, and small pebbles are suspended in the water as a mixture. If the students did not build a terrarium, mix dirt with water in a jar and stir to show how the particles are suspended when the water is moving. You could create a canyon on a baking sheet. Fill a shallow pan with soil. To slowly pour water on the soil, poke a hole in the side of a Styrofoam cup half an inch from the bottom. Set the pan at a low angle. At the high end set the cup and fill it with water. The water will trickle out and make a small canyon in the pan.

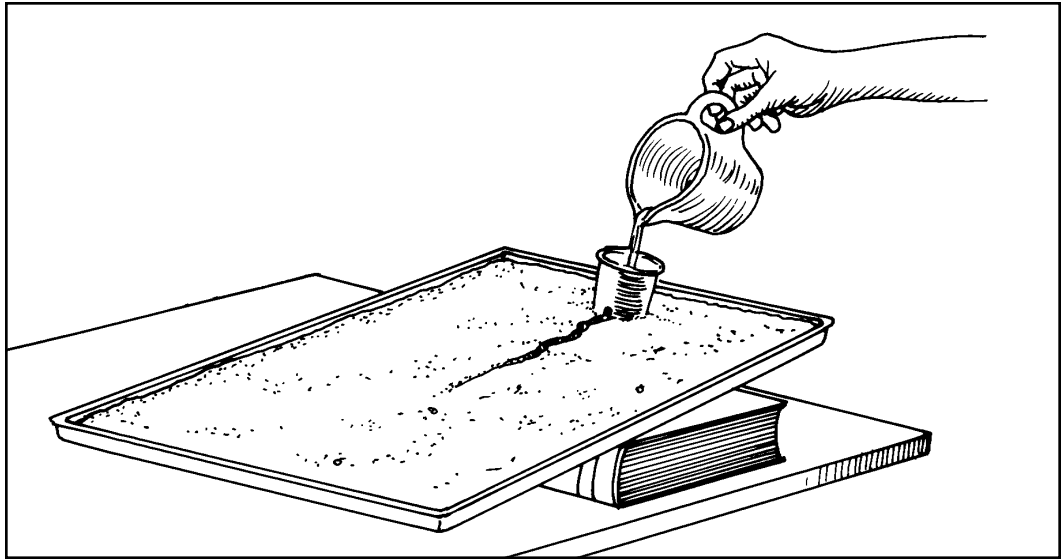

## Dissolving

Water can dissolve minerals from rock and soil. For example, mineral water comes from deep within the ground. Tell students to watch salt crystals disappear as they stir a teaspoon full into a glass of water. By tasting, compare a glass of salted tap water to one of plain tap water. Ask students if they have ever swam in the ocean. Did they swallow any water? How did it taste? Why?

## Activities

Erosion/Drought.

1. Erosion Field Trip: Visit muddy creeks, ponds, river deltas, flood plains, or hillsides plagued by erosion. Explain how water washes away soil and then deposits it in another location.
2. Film or photograph viewing: Let the students watch films or study pictures of drought-stricken farmlands to see what happens when valuable topsoil is blown away. Show photographs from NASA Space Shuttle flights (see lithograph "Water is a Force Changing") of soil-laden rivers flowing into the ocean such as the mouth of the Amazon River. Photos from space show the huge areas subjected to flooding and the large volumes of water carrying soil. The color lithograph of the Nile River Delta/Sinai Peninsula shows how the river erodes the banks and carries soil down river. The soil is eventually deposited at the mouth of the river, where the materials form a new land mass.

3. Impact on Human Lives: Find magazine and newspaper stories about floods, especially those that describe the plight of individual farmers and the efforts of volunteer sandbaggers, rescue groups, water and sewer pump-station managers. Read the news stories to the students and ask them to embellish them with more details and pictures. They could invent additional family members and describe what happened to those people, too. Create little books, like photo albums, illustrated with drawings about these flood-time “heroes.”

## Discussion

What problem does erosion present for farmers and for nearby waterways? How can farmers prevent erosion? Erosion also affects forests and beaches; what needs to be done to protect these lands?

- Erosion washes away rich topsoil—the soil in which plants grow best. Waterways are affected by runoff of chemical fertilizers and manure. Farmers can prevent erosion by carefully plowing their fields and planting another crop or hay after harvest.
- Foresters should avoid clearcutting trees and replace trees that they have logged.
- To stop beach erosion, people should maintain or plant grasses and trees, import sand after erosion has occurred, and avoid using jetties that trap sand in one area of the beach at the expense of another.



# GLOBAL CHANGE

---

## Global Environmental Impacts

---

### Introduction

To recognize the impact of human activities on the Earth system, students should be introduced to some of the changes affecting the whole planet. This unit illustrates examples of land-use changes and global warming and cooling. Students' model Earth terrariums will be used to demonstrate the greenhouse effect and the difference between global warming and cooling. Global change is a complicated subject even for scientists. An integrated approach to Earth science research is needed to understand how local and regional impacts can become global-scale environmental problems.

### Materials

Terrarium or jar, and U. S. maps showing coasts.

### Objectives

The student will be able to:

- Associate global change vocabulary words with pictures of environmental changes.
- Recognize that human activities are a force of global change on Earth (desertification, disappearance of forests, air pollution, global warming).
- Demonstrate that changes to one of the components in the terrarium can cause changes to all the components.
- As a member of a team, demonstrate how the terrarium is a greenhouse.

### Visuals

NASA Lithograph: Water is a Force of Change

### Vocabulary

Deforestation	Greenhouse	Rain Forest
Desert	Pollution	Volcanoes
Global warming		

## Land-Use Changes

Deserts occur naturally, but people also help to create them. In their search for more farmland, people around the world have pushed into areas that naturally supported only grasses and shrubs, like the Midwestern prairie. These plants, with their deep root mat and/or succulent leaves and stems, adapt to periodic drought. However, when farmers plowed under these plants and planted food crops that depended on greater rainfall and richer soil, they damaged the area's natural balance.

During short-term droughts, these ill-adapted crops failed to hold water and large areas dried out. Livestock worsened the situation. Confined by humans to pastures, they overgrazed and killed the roots of native grasses. When rain did come, it washed away the mineral-rich topsoil. The farmers eventually moved on, leaving behind unproductive, dry land. The photo of the Sinai Peninsula in Algeria shows what deserts look like from space. Some of the desert lands in the Middle East were fertile farmlands a few thousand years ago.

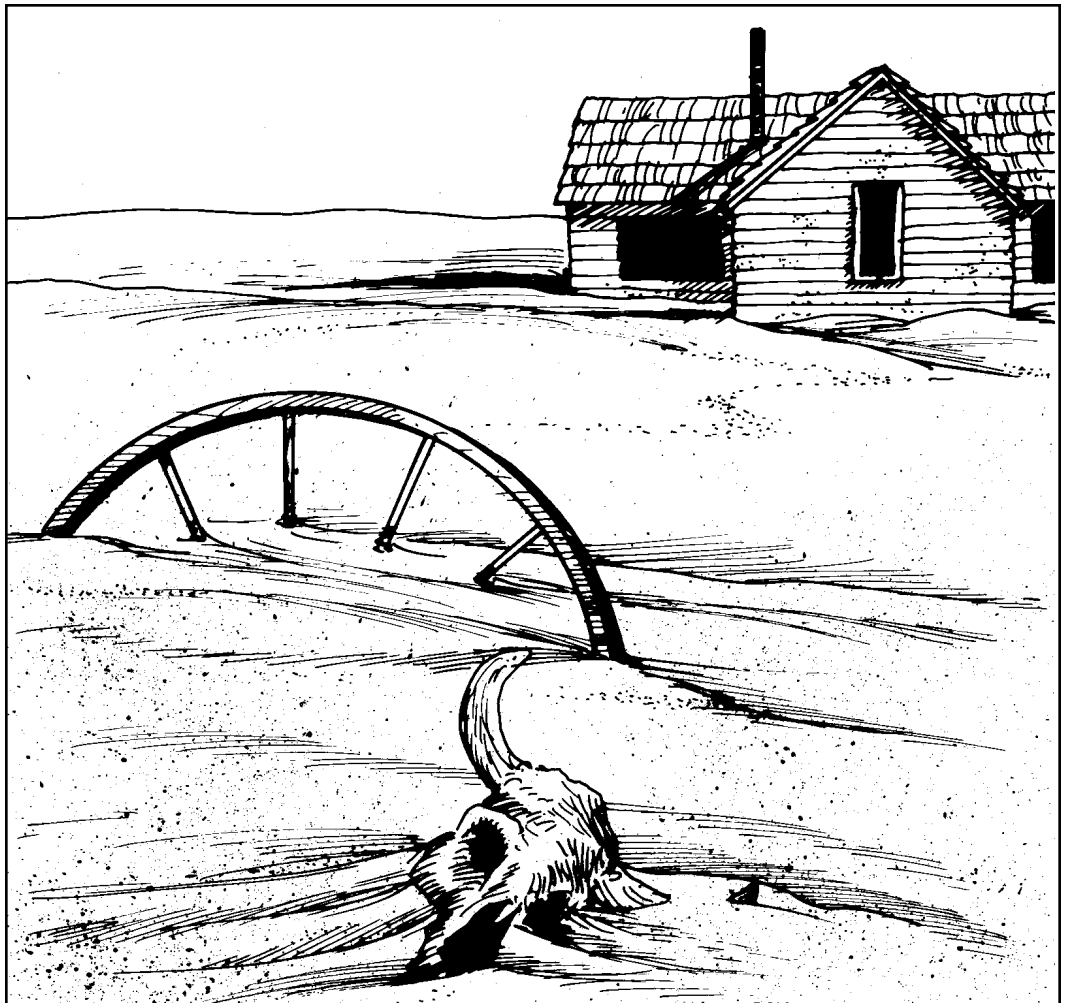

## Greenhouse Effect

In recent history, human activities have increased significantly the amount of greenhouse gases in the atmosphere. These gases—carbon dioxide and ozone—allow the Sun's light to pass through the atmosphere and heat the land and oceans. They also reflect ground-generated heat that otherwise would escape into space. A similar kind of warming happens in a greenhouse or glass-covered terrarium when the glass traps heat inside. Scientists have used computer models to predict that global temperatures could rise as much in the next 100 years as they have over the last 18,000 years.

High and low clouds reflect and pass light differently. High, thin (cirrus) clouds are like the glass in the jar or terrarium; they let radiation pass through, but do not let heat out. Low, thick (stratocumulus) clouds, on the other hand, are cooling clouds; they reflect light away before it reaches the ground.

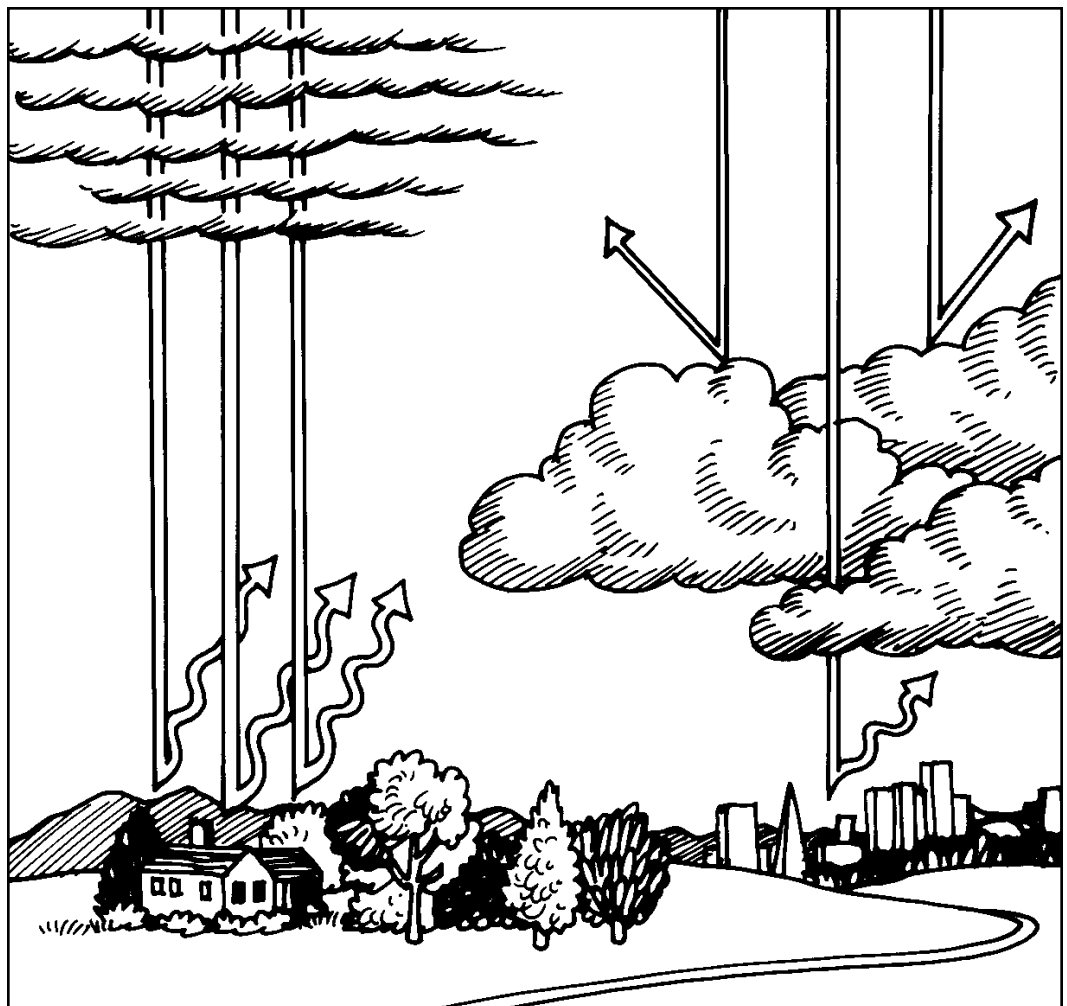



## Observation

Terrarium Observation: Part 5, The Greenhouse.

Fill a terrarium or glass jar with dark soil; place a thermometer inside; cover the terrarium; and place it in the sunlight for one hour. Take the temperature inside the glass terrarium and compare it to the temperature of the room. Temperatures are warmer inside the terrarium. Explain what has happened. The air inside the glass containers represents the atmosphere, and the dark soil, land. When the soil is heated by the sunlight, the radiated heat is trapped by the glass, creating a greenhouse effect.

## Field Trip

Visit a Greenhouse.

If possible on a cold sunny day, visit a local greenhouse, zoo with a jungle habitat, botanical garden, or solar-heated atrium. Students can feel what it is like to be inside a greenhouse. Have the students identify the life-supporting components. What cycles can they identify? Ask them to compare the greenhouse to their terrarium and to the whole Earth.

## Activities

Global Warming Map.

Discuss with students how a temperature change of a few degrees could drastically change our world. If global temperatures rise, the heat would melt glacial ice and raise sea levels (see glacier photograph in the lithograph, "Water is a Force of Change). What would happen to us if all the world's coasts flooded? On a U.S. map, identify some of the coastal cities (low-lying areas) that might be covered with water if sea levels rise. What would happen inland to cities and farms if the climate became warmer? Are there other ways people's lives would change due to global warming in your area? It is okay to speculate.

Global Warming Mural.

Have students draw a picture of the places around them after global warming has taken place. Display the pictures as part of a mural on "Global Warming." The pictures could be mounted on a map of the world.

## Global Cooling

Naturally occurring volcanic eruptions and large forest fires can impact the Earth's system just like human-caused air pollution. These events can fill the atmosphere with dust and darken the global "greenhouse roof," which results in cooling. This is why scientists must study Earth as a system to understand how the planet is changing beyond these natural events.

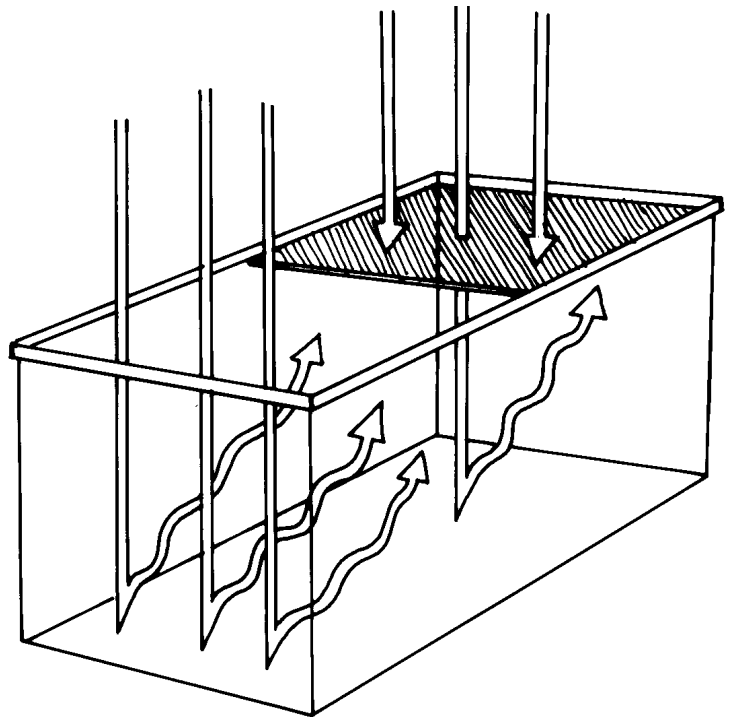

### Observation

Terrarium: Part 6, Global Cooling.

Cover the terrarium with smoked or dirty glass or colored plastic wrap. Place it in the sunlight and take the temperature inside the terrarium after an hour. In the same way that volcanic dust or air pollution has a cooling effect on the atmosphere, the temperature will not increase as much as it did when the clear glass was used to cover the terrarium (Terrarium Observation, Part 5).

Global Cooling.

Examine photos that show urban pollution, volcanic explosions, Amazon basin fires, and wildland fires in the Los Angeles area. These are sources of air pollution that have a cooling effect on Earth's atmosphere. Show photos of the human activities that cause air pollution and fires. Discuss how people could change their behavior and technology to prevent air pollution.





# MISSION TO PLANET EARTH

Unit 4

---

## Satellites: Observing the Whole Earth

---

### Introduction

The Mission to Planet Earth is NASA's program to determine scientifically whether Earth's climate is changing and to assess the contribution of human activities. Scientists are using satellite-borne instruments to measure the interactions of the atmosphere, oceans, and solid Earth through hydrologic and biogeochemical cycles. Scientists need data from many sources to get a better picture of the whole system. You could compare the Mission to Planet Earth program to other NASA programs where the agency has developed sophisticated instruments and satellites to study the environments of other planets in our Solar System.

Satellites are particularly effective because they can cover the entire globe every few days. They can see a whole ocean at once to study wind, temperatures, and currents. Scientists use advanced computers to analyze the data from satellites and make predictions using mathematical "models." Models could be said to work like a computer game, but in this case, the game simulates the Earth system. With data about how Earth works as a system, we can understand human impacts and cooperate as nations to make sure the planet remains healthy and life-sustaining.

### Materials

Scissors, cardboard, paper, string, paint or crayons, egg cartons, paper towel and toilet paper rolls, paper or foil cupcake holders, paper plates, aluminum foil, poster paint.

### Objectives

Students will be able to:

- Identify satellite components: antennae, solar arrays, and instruments to study Earth from space.
- Associate color data images with NASA's Mission to Planet Earth program.
- Recognize that Earth's climate can be studied by a variety of professionals.

## Visuals

- NASA Lithograph: TOPEX/Poseidon
- NASA Lithograph: First Image of Global Biosphere
- NASA Lithograph: Viking Orbiter 1 Mars Mosaic
- NASA Lithograph: Sea Surface Temperature
- NASA Lithograph: World Cloud Cover Pattern
- NASA Lithograph: Water is a Force of Change
- NASA Lithograph: Viking Orbiter 1 Mars Mosaic

## Vocabulary

Computer

Model

Data

Satellite

# Satellite Parts

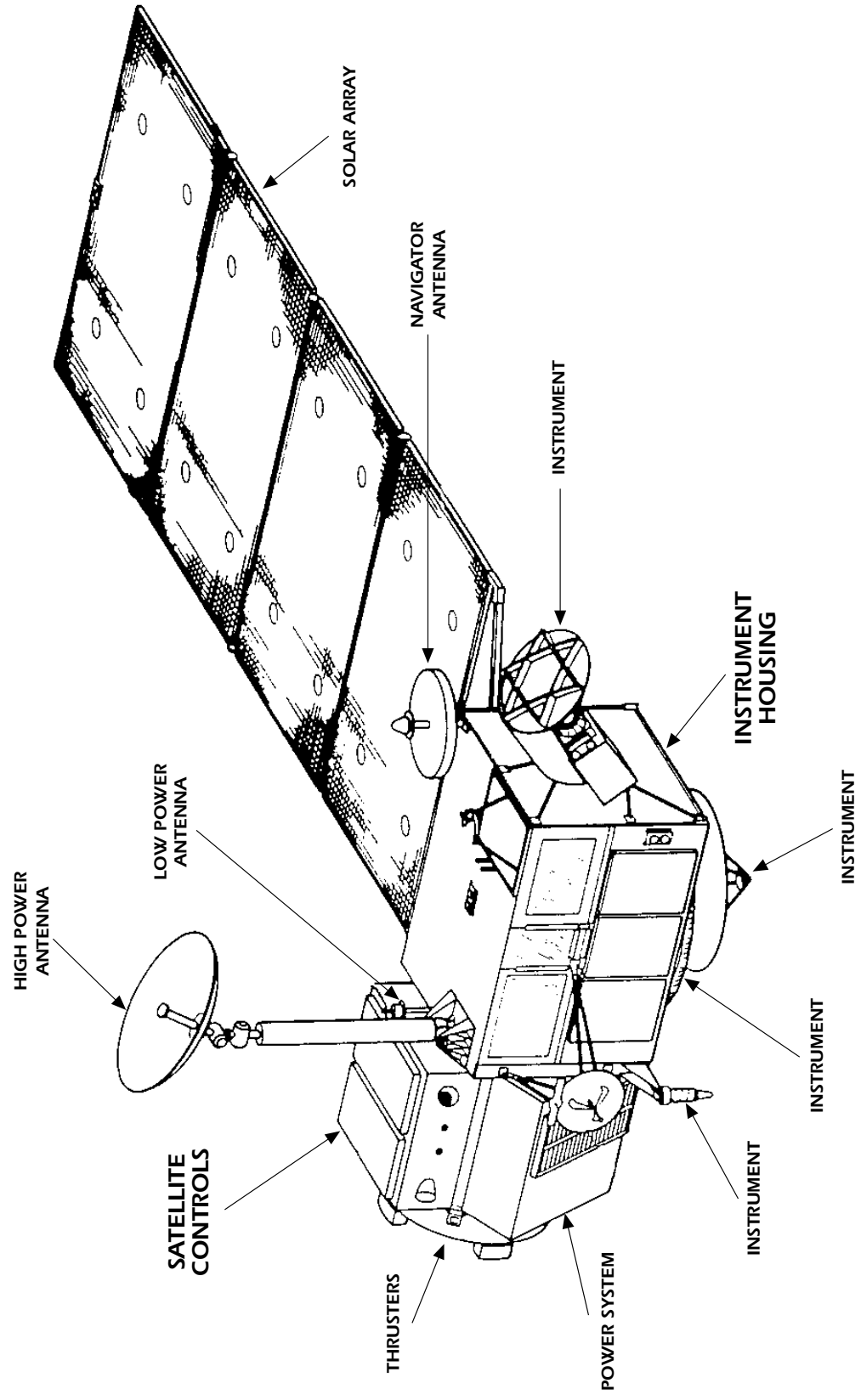

# TOPEX/Poseidon

---

## Satellites

Earth-observing satellites observe our planet from paths called orbits, many of which are greater than 400 miles above the ground. That distance is at least as far as Washington, D.C. to Boston, Massachusetts. Satellites are so high above Earth and travel so quickly that, in the right orbit, a satellite can pass over every part of Earth once every few days. Such orbits allow satellites to study and take pictures of all of Earth's features: land, plant life, oceans, clouds, and polar ice. Some satellites, such as those used for weather forecasting, are placed in fixed orbits to look at Earth continuously.

---

## Instruments

Satellite instruments are like special cameras that see and take pictures in different kinds of light, such as in ultraviolet (invisible energy from the Sun that causes sunburns) and infrared (heat waves). From satellite data, we can see farmers' fields and tell whether crops are healthy. This tells us about the food supply. We can see the forests and tell where something is killing trees. This tells foresters that they may need to look for blight or gypsy-moth infestations. We can see forest fires and tell how fast the forests are being cut down. Satellites also see clouds, hurricanes, lightning, and rain. In addition, we can see the temperatures and movements of ocean currents. And from the color of the oceans, we can see the abundance of tiny plants, called phytoplankton, which are an important food source for fish.

---

## Satellite Design

Engineers design satellites to support instruments flown in space. Satellites must be light enough to be carried into space on rockets, yet strong enough to withstand the forces of launching. The materials used must handle hot and cold temperature extremes because most satellites will pass from the day to night side of Earth many times in 24 hours. Scientists use special paints on the instruments to control temperature. (In Unit One we learned that dark colors absorb solar heat and light colors reflect it.) Satellites' solar cells extend like wings to capture solar energy and convert it into electricity. When the satellite is on the night side of Earth, it runs on batteries that are recharged during the day from solar energy.

---

## Data

Data come down as electronic signals from satellites, and engineers and scientists convert them into measurements useful to us on Earth. For studying weather, scientists create maps of clouds. Meteorologists compare the satellite maps to their ground data and learn more about weather patterns. Scientists compare ocean-color data gathered by a satellite to measurements taken by oceanographers on ships showing the abundance of phytoplankton. Microwave radar signals from space are compared to rainfall measurements on Earth. Computer engineers organize and store vast quantities of satellite data so that the information can be sent via computer networks to scientists around the globe.

---

## Modeling

In the same way students made a terrarium as a model of Earth, scientists use computers to create models to predict what will happen when global changes occur. Will the temperatures rise because of warming caused by greenhouse gases? Can we see a warming trend even if a major volcano has erupted? A model is like a “what-if” game. When you play “what-if” using a computer model, your prediction is based only on available data and scientific principles.

## Activities

Demonstrating Heat Sensors.

Show students how heat-sensing instruments work by letting them hold heat-sensitive cards (frequently given away at health fairs), “mood rings,” or aquarium thermometers. The warmer you are, the darker the color appears on the card or ring registering your body temperature. The data in the lithographs, “World Cloud Cover Pattern” and “Global Sea Surface Temperature,” were collected during observations from satellites carrying heat-sensing or infrared instruments.

Satellite Construction.

1. Satellite Construction: Students can make their own satellites out of paper, cardboard, and recycled containers. Use foil or plastic wrap on a cardboard frame for solar arrays; paper or foil plates could be antenna dishes; aluminum foil could be a heat-resistant metallic surface. Encourage the students to pretend that their satellites are going to observe components of the Earth system found in their terrariums or



aquariums. Let them use their imaginations to determine the satellite's shape, instruments, and the equipment it will need according to what they are going to observe. When they are finished, hang the satellites from the ceiling with fishing line. The satellites could be "observing" the terrariums or aquariums or their region of the country. Show students the lithograph, "TOPEX/Poseidon." Note in the illustration its orbit and what it is observing. Point to the solar arrays, antennae, and instruments.

2. **Satellite Launch and Deploy:** Divide the class into launch teams; let them pick roles and dramatize a Space Shuttle or rocket launch and satellite deploy. Use real or invented language for their missions. Each child could bring in baseball cap. Attach the job label to the cap; later have them try different jobs by switching labels. Such jobs are Mission Commander, Payload Commander, Pilot, Mission Specialists, Project Scientists, Flight Director.
3. **Data:** Scientists study Earth by taking measurements of light that we cannot see. They assign artificial colors to represent each measurement. It's as though you were coloring a picture, and you had to decide which crayon to use for each part of the picture. Each child should draw and color "data" collected by their satellites (see data map, page 29). Choose different colors to represent each kind of measurement. For example, the healthiest plants could be compared to the progressively more dried-out plants. The healthy plants could be represented by reds, oranges and yellows. Try the same color scheme to compare conditions in the different terrariums. Look at the lithograph, "The First Image of the Global Biosphere." These ocean data are indicated by red and orange for high concentrations of plant life in the oceans (phytoplankton), blue and violet for lower concentrations. On the land, forests are indicated by all shades of the color green. Semi-arid steppes and tundra are orange, and deserts and ice are yellow. A black and white map of Earth is included for classes that want to try coloring global Earth data.

# Our Mission to Planet Earth

## Surface Temperature

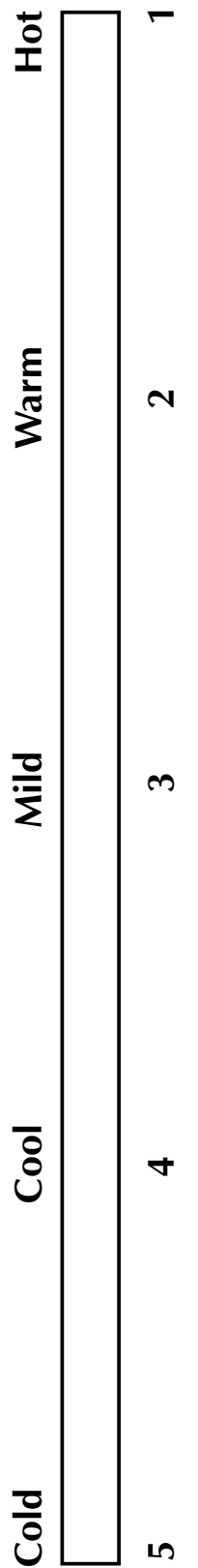
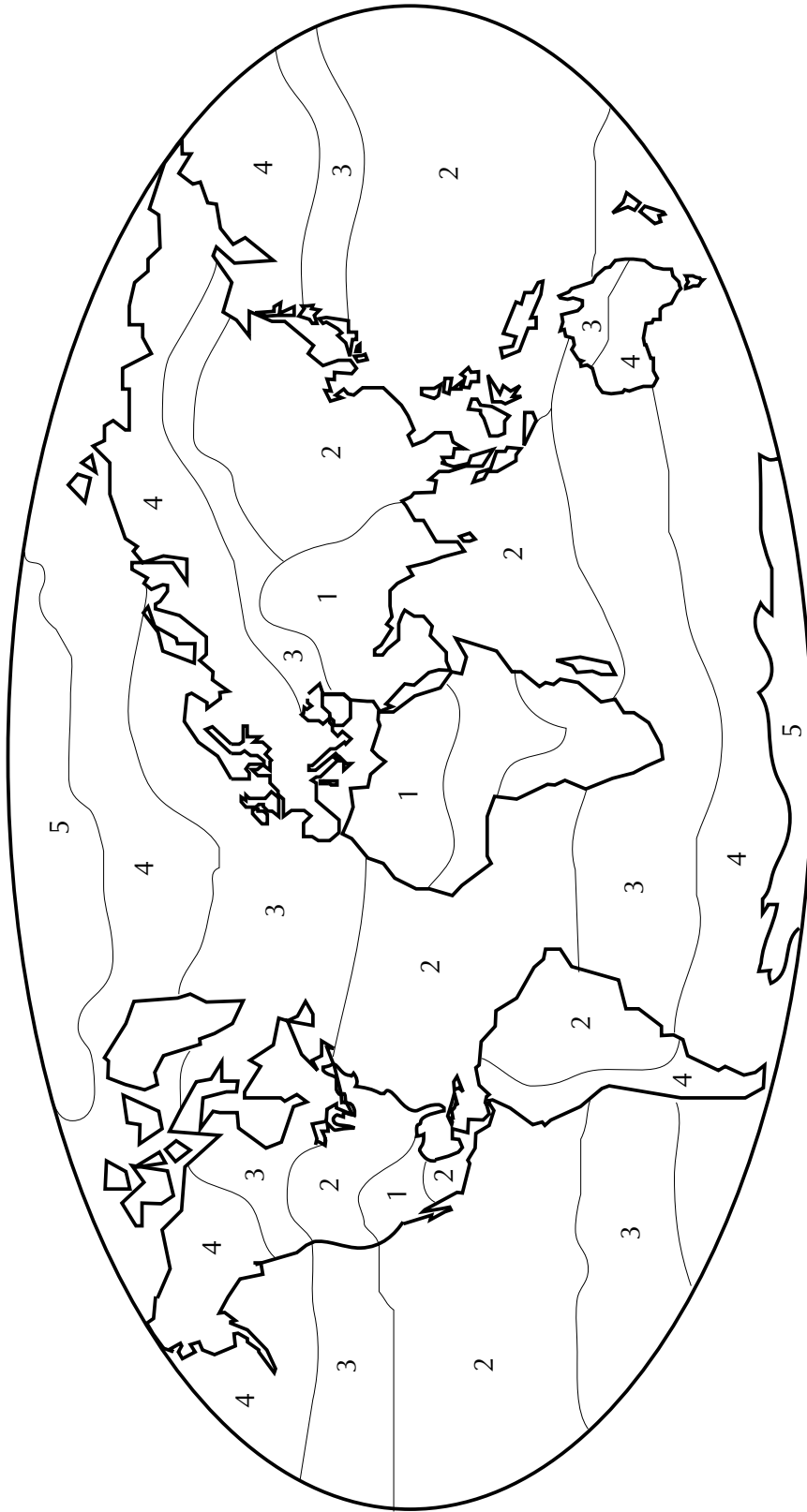

---

## Careers

---

### Activity

Mission to Planet Earth Careers.

Let students pick a career. Ask them to tell a story in the form of an autobiography about how their Earth science career (“what I want to be when I grow up”) could help improve knowledge of Earth or life on Earth. Improvise a costume and tools. Find or draw pictures of the Earth component they want to study, and ask the students to draw and color examples of data they will obtain.

1. Atmospheric Chemist: I study the atmosphere over time to understand what is natural and what has changed because of pollution. I take samples from aircraft or balloons, conduct laboratory experiments, and create computer models.
2. Climatologist: I study weather on a big scale over a long period of time—even centuries. I gather samples that show long-term histories, like those taken from the bottom of the ocean or from polar ice cores. I also study the growth rings of trees, and then I predict the future climate.
3. Mathematician Computer Scientist: I invent and improve computers and programs to study data about Earth. I know how to create programs on computers that are more complicated than computer games. I make the work of many scientists possible by keeping all the satellite information easy to access and understand.
4. Sociologist: I study people in large populations—how they live, grow food, and manufacture things. From what I learn about large numbers of people, I can help predict what people could do to the environment. My work helps decision makers make policies that help prevent damages to the environment.
5. Ecologist: I study various forms of life on Earth and how they interact. I go out in ships or use aircraft and satellites to measure where and how healthy the plants and animals are in their habitats. See the lithograph, “First Image of the Global Biosphere.” We can learn from observing the abundance of life what changes are occurring environmentally on Earth.

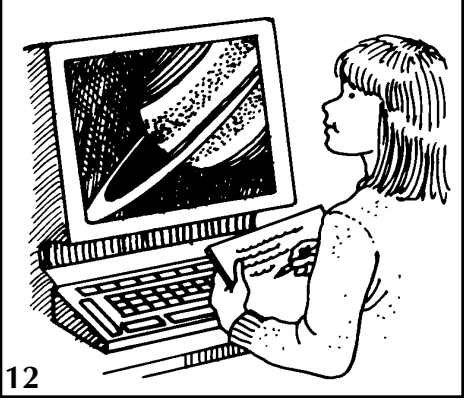
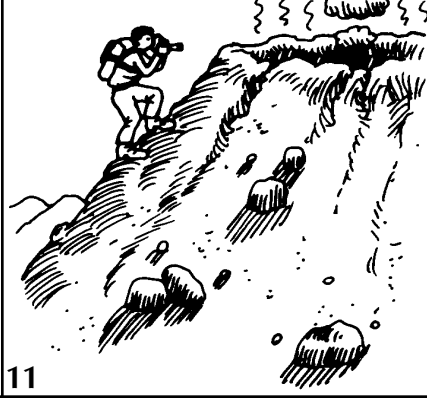
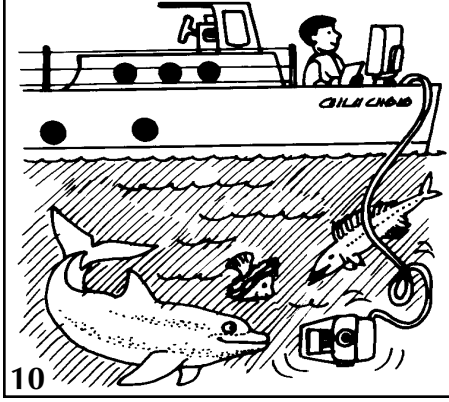
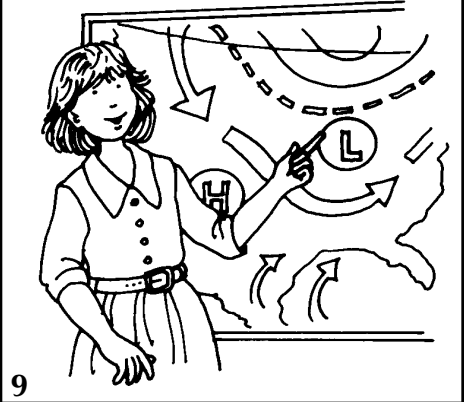

6. Geologist/Geophysicist: I study how Earth is formed, what has happened to it since then, and what might happen to it in the future. I study volcanoes, earthquakes, and landslides. I can study rocks and rock formations and determine the geological history of an area.
7. Glaciologist: I study glaciers in the Arctic and Antarctic as well as those formed in the tallest mountains. I study temperatures, snow accumulation, and deep ice cores to understand what is happening to the glaciers. I also use satellites and aircraft to get these data (see lithograph; "Water is a Force of Change").
8. Hydrologist: I study the water cycle. I study where the water goes, what elements it contains, and whether its chemistry has changed. My research often is used to determine where droughts occur and why fish populations decline.
9. Meteorologist: I study weather, the local short-term changes that affect how we live every day. I use satellites and ground measurements to predict the weather. You can see some meteorologists on television news. See the lithographs, "World Cloud Cover Pattern" and "Water is a Force of Change" (hurricane photograph).
10. Oceanographer: I study oceans and how they change. I work on ships or in aircraft and get data from floats and satellites. See the lithograph, "Global Sea Surface Temperature."
11. Volcanologist: Using ground instruments, I study volcanoes and how they influence the climate. I use satellite and robots to gather data when the volcanoes are active and become too dangerous to go near.
12. Planetologist: I study planets other than Earth. When I compare planets like Mars, which has very little water compared to Earth, I can learn more about what could happen to our planet. The only way I can study Mars is by observing the planet with large telescopes or using data collected by satellites, such as that obtained by Voyager. Compare the lithograph of Earth from space with the litho, "Viking Orbiter 1 Mars Mosaic."

---

## NASA Resources for Educators

---

**NASA's Central Operation of Resources for Educators (CORE)** was established for the national and international distribution of NASA-produced educational materials in audiovisual format. Educators can obtain a catalogue and an order form by one of the following methods:

- NASA CORE  
Lorain County Joint Vocational School  
15181 Route 58 South  
Oberlin, OH 44074
- Phone (440) 774-1051, Ext. 249 or 293
- Fax (440) 774-2144
- E-mail [nasaco@leeca.esu.k12.oh.us](mailto:nasaco@leeca.esu.k12.oh.us)
- Home Page: <http://spacelink.nasa.gov/CORE>

### **Educator Resource Center Network**

To make additional information available to the education community, the NASA Education Division has created the NASA Educator Resource Center (ERC) network. ERCs contain a wealth of information for educators: publications, reference books, slide sets, audio cassettes, videotapes, telelecture programs, computer programs, lesson plans, and teacher guides with activities. Educators may preview, copy, or receive NASA materials at these sites. Because each NASA Field Center has its own areas of expertise, no two ERCs are exactly alike. Phone calls are welcome if you are unable to visit the ERC that serves your geographic area. A list of the centers and the regions they serve includes:

*AK, AZ, CA, HI, ID, MT, NV, OR,  
UT, WA, WY*

NASA Educator Resource Center  
Mail Stop 253-2

#### **NASA Ames Research Center**

Moffett Field, CA 94035-1000  
Phone: (650) 604-3574

*CT, DE, DC, ME, MD, MA, NH,  
NJ, NY, PA, RI, VT*

NASA Educator Resource Laboratory  
Mail Code 130.3

#### **NASA Goddard Space Flight Center**

Greenbelt, MD 20771-0001  
Phone: (301) 286-8570

*CO, KS, NE, NM, ND, OK, SD, TX*

JSC Educator Resource Center

Space Center Houston

**NASA Johnson Space Center**

1601 NASA Road One

Houston, TX 77058-3696

Phone: (281) 483-8696

*FL, GA, PR, VI*

NASA Educator Resource Laboratory

Mail Code ERL

**NASA Kennedy Space Center**

Kennedy Space Center, FL 32899-0001

Phone: (407) 867-4090

*KY, NC, SC, VA, WV*

Virginia Air and Space Museum

NASA Educator Resource Center for

**NASA Langley Research Center**

600 Settler's Landing Road

Hampton, VA 23669-4033

Phone: (757) 727-0900 x 757

*IL, IN, MI, MN, OH, WI*

NASA Educator Resource Center

Mail Stop 8-1

**NASA Lewis Research Center**

21000 Brookpark Road

Cleveland, OH 44135-3191

Phone: (216) 433-2017

*AL, AR, IA, LA, MO, TN*

U.S. Space and Rocket Center

NASA Educator Resource Center for

**NASA Marshall Space Flight Center**

P.O. Box 070015

Huntsville, AL 35807-7015

Phone: (205) 544-5812

*MS*

NASA Educator Resource Center

Building 1200

**NASA John C. Stennis Space Center**

Stennis Space Center, MS 39529-6000

Phone: (228) 688-3338

NASA Educator Resource Center

JPL Educational Outreach

Mail Stop CS-530

**NASA Jet Propulsion Laboratory**

4800 Oak Grove Drive

Pasadena, CA 91109-8099

Phone: (818) 354-6916

*CA cities near the center*

NASA Educator Resource Center for

**NASA Dryden Flight Research Center**

45108 N. 3rd Street East

Lancaster, CA 93535

Phone: (805) 948-7347

*VA and MD's Eastern Shores*

NASA Educator Resource Lab

Education Complex

Visitor Center Building J-1

**NASA Wallops Flight Facility**

Wallops Island, VA 23337-5099

Phone: (757) 824-2297/2298

---

**Regional Educator Resource Centers (RERCs)** offer more educators access to NASA educational materials. NASA has formed partnerships with universities, museums, and other educational institutions to serve as RERCs in many states. A complete list of RERCs is available through CORE, or electronically via NASA Spacelink at <http://spacelink.nasa.gov>

**NASA On-line Resources for Educators** provide current educational information and instructional resource materials to teachers, faculty, and students. A wide range of information is available, including science, mathematics, engineering, and technology education lesson plans, historical information related to the aeronautics and space program, current status reports on NASA projects, news releases, information on NASA educational programs, useful software and graphics files. Educators and students can also use NASA resources as learning tools to explore the Internet, accessing information about educational grants, interacting with other schools which are already on-line, and participating in on-line interactive projects, communicating with NASA scientists, engineers, and other team members to experience the excitement of real NASA projects.

Access these resources through the NASA Education Home Page: <http://www.hq.nasa.gov/education>

**NASA Television (NTV)** is the Agency's distribution system for live and taped programs. It offers the public a front-row seat for launches and missions, as well as informational and educational programming, historical documentaries, and updates on the latest developments in aeronautics and space science. NTV is transmitted on the GE-2 satellite, Transponder 9C at 85 degrees West longitude, vertical polarization, with a frequency of 3880 megahertz, and audio of 6.8 megahertz.

Apart from live mission coverage, regular NASA Television programming includes a Video File from noon to 1:00 pm, a NASA Gallery File from 1:00 to 2:00 pm, and an Education File from 2:00 to 3:00 pm (all times Eastern). This sequence is repeated at 3:00 pm, 6:00 pm, and 9:00 pm, Monday through Friday. The NTV Education File features programming for teachers and students on science, mathematics, and technology. NASA Television programming may be videotaped for later use.

For more information on NASA Television, contact:

NASA Headquarters

Code P-2

NASA TV

Washington, DC 20546-0001

Phone: (202) 358-3572

NTV Home Page: <http://www.hq.nasa.gov/ntv.html>

### **How to Access NASA's Education Materials and Services, EP-1996-11-345-HQ**

This brochure serves as a guide to accessing a variety of NASA materials and services for educators. Copies are available through the ERC network, or electronically via NASA Spacelink. NASA Spacelink can be accessed at the following address: <http://spacelink.nasa.gov>



Listed below are additional Mission to Planet Earth Materials available through the Educator Resource Center Network or NASA Spacelink.

### **Teacher Guides**

- “Atlas 1 Earth’s Mysterious Atmosphere Teacher’s Guide” (EP-282 11/91)
- “La misteriosa atmosfera de la Tierra” (EP290 3/93)
- Atlas 2 Teacher’s Guide with Activities: Atmospheric Detectives (EP285 11/92)

### **Lithographs**

- “Earth View” HQL-331
- “Nimbus-7 TOMS Images: The 8 Marches” HQL -366
- “Nimbus-7 TOMS Images: The 12 Octobers” HQL-308
- “Nimbus-7 Ocean Ice Maps” HQL-319
- “NASA and World Food Production” HQL-305
- “The Upper Atmosphere Research Satellite” HQL-207

### **Brochure**

- “NASA’ s Mission to Planet Earth”

The following Mission to Planet Earth materials are available by writing Goddard Space Flight Center, Educator Resource Center, Code 130, Greenbelt, MD 20771

### **Fact Sheets**

- “EOS: Understanding Earth on a Global Scale”

Mission to Planet Earth series:

- “Ozone: What is it and why do we care about it?”
- “Clouds and the Energy Cycle”
- “El Niño”
- “Global Warming”
- “Volcanoes”
- “Biosphere”
- “Polar Ice”

*NASA Facts* are documents that provide general information and background on NASA-related missions, research topics and activities.

The following videos, slide sets, and videodisc are available through CORE:

**Videos**

- “Liftoff to Learning: The Atmosphere Below”
- “TOPEX/Poseidon: A Mission to Planet Earth” (9 minutes)
- “Mission to Planet Earth” Satellite Video Conference  
April 14, 1993 (\$24.00 plus \$3.50 shipping)

**Slide Sets**

“Atlas 1: Studying Mysteries in the Earth’s Atmosphere”  
“Volcanoes of Hawaii and the Planets”

*Space Shuttle Earth Observing Photography* Videodisc contains approximately 91,500 still images of the Earth taken during Space Shuttle missions from 1981-1991. The videodisc package includes the videodisc, a guide to the images, and two IBM-formatted disks containing an image description database. The price for the package is \$55 and is available from NASA CORE.

---

Office of Mission to Planet Earth  
Office of Human Resources  
and Education



---

## Lithographs for Use with this Packet

---

### **NASA Lithographs**

- Apollo 17 View of Earth
  - Water is a Force of Change
  - Global Sea Surface Temperature
  - First Image of the Global Biosphere
  - World Cloud Cover Pattern
  - Topex/Poseidon
  - Viking Orbiter 1 Mars Mosaic
-

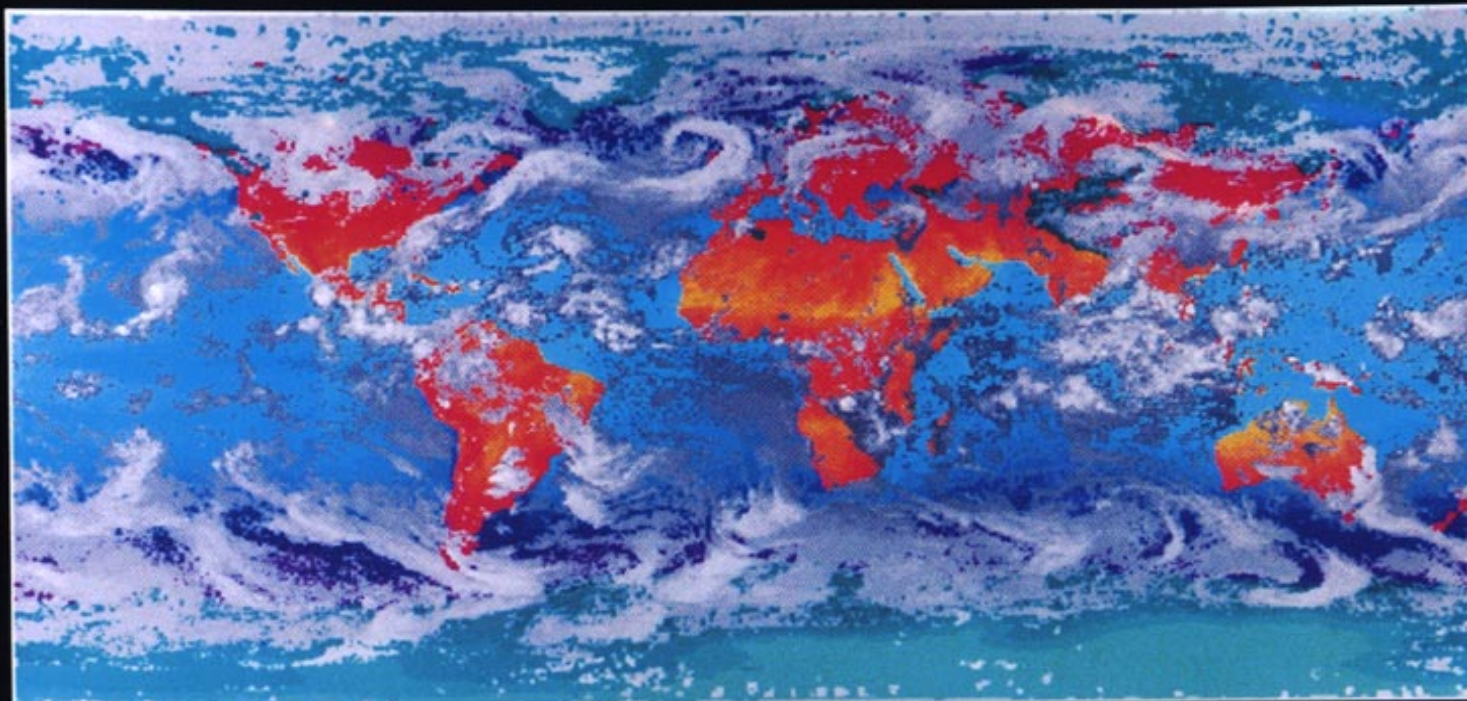

GRAPHICS BY NASA/GISS

CLOUD



WATER

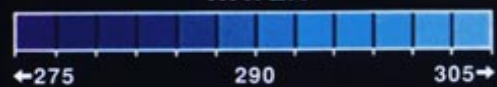

ICE/SNOW

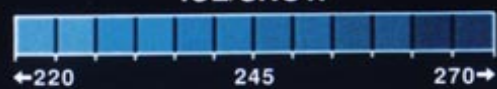

LAND





### World Cloud Cover Pattern

This illustration, produced by the Goddard Institute for Space Studies New York, NY, as a part of NASA's program of Earth-science research, show the world's cloud cover pattern on October 15, 1983, assembled from weather satellite images made at infrared wavelengths. Although a single image of Earth's cloud cover had been assembled from multiple satellite images before, this picture is the first time that an image had been collected for such a small time period, in this case only about one hour. This kind of information enables scientists to study global cloudiness to improve our understanding of how clouds affect climate.

The images were taken from two National Oceanic and Atmospheric Administration (NOAA) polar orbiting satellites and the geostationary satellites: METEOSTAT, operated by the European Space Agency; GMS, operated by the Japanese Meteorological Agency; and Geostationary Operational Environmental Satellite (GOES)-EAST and GOES-WEST operated by NOAA. The colors show the temperature at each location depending on whether clouds are present or not. Areas not covered by clouds are either oceans or land depending upon their location or ice or snow covered according to other data sets. They are represented by an aqua color scale for ice or snow, a blue color scale for water, and a yellow color scale for land. For cloudy locations, colder temperatures are indicated by brighter grey shades. Thus, the same temperature value may have four different

colors depending on its classification. All temperatures scales are expressed in degrees Kelvin.

The data illustrated in this picture have been collected by the International Satellite Cloud Climatology Project of the World Climate Research Program since July 1983. Analysis of these data provides an unprecedented view of the world's cloud formations. Although scientific study of clouds has been carried out with both ground and aircraft instruments for many decades, only with the use of satellites in the last 15-20 years have scientists been able to see the larger scale and global view of cloud structures.

This study is part of NASA's multiyear global research program called Mission to Planet Earth that will use ground-based, airborne and space-based instruments to study Earth as a complete environmental system. Mission to Planet Earth is NASA's contribution to the U.S. Global Change Research Program, a multi-agency effort to understand, analyze, and better predict the effect of human activity on Earth's environment. Goddard Space Flight Center's projects for Mission to Planet Earth include: the Upper Atmosphere Research Satellite Mission; Earth Probes, such as the Tropical Rainfall Measuring Mission; the Total Ozone Mapping Spectrometer; and the Earth Observing System, the most ambitious science mission ever undertaken.

### For The Classroom

#### Research topics:

- Cloud formation
- Latent heat
- Satellite orbits

1. Have students keep a daily log in which they measure and record the temperature and observe percent cloud cover the same time each day. Continue this for one month and then graph the results. Do the students see any trends or relationships?
2. Have students research the different types of satellite orbits. Why are two different orbits (polar orbiting and geostationary) used to get images like the one on this lithograph.
3. After discussing the characteristics of low pressure systems, have students find a major low pressure system on the lithograph.
4. How many different colors can be used to represent 295 degrees Kelvin on this lithograph?





## Apollo 17 View of Earth

Just hours after its liftoff from the Kennedy Space Center in Florida, the crew of Apollo 17 found themselves aligned with Earth and the Sun, enabling them to take this full disk view of Earth. The astronauts were coasting towards the Moon, approximately 40,000 kilometers from Earth, when this picture was taken. Because the mission took place during the beginning of the summer in the Southern Hemisphere, the Southern Hemisphere is brightly lit by the Sun. The entire continent of Africa, much of the ice-locked continent of Antarctica, and small portions of Europe and the Asian mainland are visible in this photograph. Tawny colored land masses on Africa are the Sahara, Libyan, and Arabian deserts. The dark band across Africa is the grasscovered savannah and the areas covered most y with broken clouds are the tropical rain forests. To the east of Africa is the island of Madagascar. Extensive weather systems of swirling clouds generated in Earth's atmosphere are visible from space

Apollo 17 lifted off at 12:33 a.m. on December 7, 1972. It was the last of the Apollo expeditions to the Moon. Onboard were astronauts Eugene A. Cernan (commander), Ronald E. Evans (pilot), and Harrison H. Schmitt (lunar module pilot). Three days later, their twin spacecraft, the *America* (command and service modules) and the *Challenger* (lunar lander), entered lunar orbit. Twenty-three hours later, *Challenger* with Cernan and Schmitt onboard, touched down on the lunar surface in the Taurus-Littrow region. Over the next three days, Cernan and Schmitt explored the lunar surface, deployed experiments, and collected 115 kilograms of lunar rock and soil to return to Earth for analysis and study. Following a three-day return voyage, the crew rode *America* back into Earth's atmosphere and splashed down in the Pacific Ocean.

## For the Classroom

1. How big did Earth appear to the Apollo 17 crewmembers when this picture was taken? Set up a scale model of the positions of Earth and Apollo 17 by placing a globe on a table and standing back from it at a scale distance representing 40,000 kilometers. To determine that distance, measure the diameter of the globe in centimeters. This can be done with dividers or by wrapping a string around the globe. Measure the string's length in centimeters and solve the following equation for diameter:  $C=\pi d$

Next, calculate the scale of your globe by dividing the diameter of Earth (12,756 kilometers) by the diameter of the globe in centimeters. If the answer is 500, for example, the scale of the model is 1 centimeter equals 500 kilometers.

2. Compare this picture to world maps. Are the shapes and relative sizes of Africa, Antarctica, and Madagascar the same in both the picture and the maps? If not, why is there a difference?
3. Notice the thickness of Earth's atmosphere along Earth's limb (the apparent outer edge) in this picture. Why is it so thin? (Consider how thick the atmosphere would appear in the scale of the picture and how the density of the atmosphere changes with altitude.)
4. Over the past few decades, the island of Madagascar has experienced extensive deforestation. How might this land look in a picture taken from space today?

## Reference

To learn more about the Apollo 17 mission to the Moon, look up the publication listed below:

NASA, (1975), [Apollo Expeditions to the Moon](#). National Aeronautics and Space Administration, SP-350, Washington, D.C.





National Aeronautics and  
Space Administration

## Water is a Force of Change

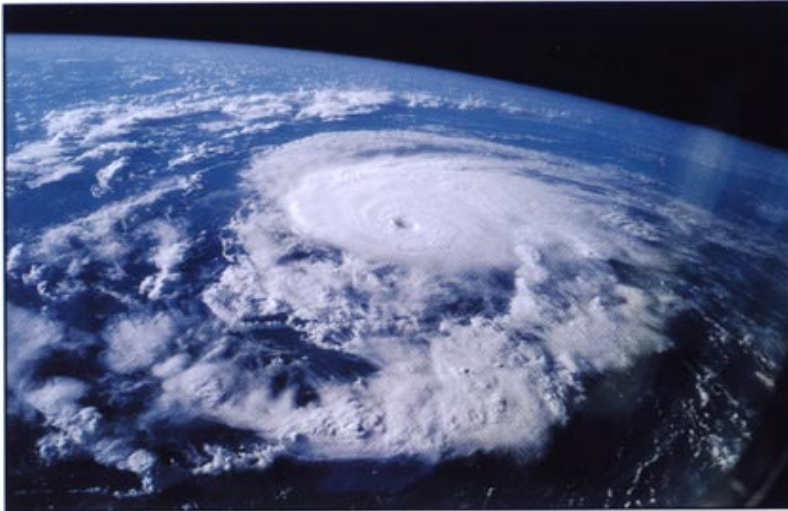

Hurricane Bonnie, Atlantic Ocean



Nile River Delta/Sinai Desert



Glaciers in the Andes Mountains



Mouth of the Amazon River



## Water is a Force of Change

As we look at Earth from the vantage point of outer space, we can't but help notice how important water is to Earth's surface. Three quarters of our planet is covered with liquid and frozen water. The land surface is shaped by water's movements. Living things need water for survival. Water exists as vapor in the atmosphere and is the stuff of clouds. As a renewable resource, water transforms through three states of matter— solid, liquid, and—gas as it cycles from the oceans to the atmosphere, to the land, and back to the oceans. Water and its effects are the dominant features Space Shuttle astronauts see from space. Water is a powerful force of change.

**Upper left: Hurricane Bonnie, Atlantic Ocean (STS 47-151-618)**

Among the most destructive forces of nature, hurricanes and typhoons are driven by the Sun's heat and act as a great pressure relief valve for Earth's atmosphere. The view of Hurricane Bonnie was captured by the Crew of STS-47 as the storm swirled about 800 kilometers away from Bermuda near 35.4 degrees north latitude and 56.8 degrees west. At this stage in its life, Hurricane Bonnie has well-developed eye where air currents are relatively calm. Window reflections are visible on the right side of the picture.

**Upper right: Nile River Delta/Sinai Desert (STS 50-153-020)**

The presence and the absence of water are both clearly seen in this STS-50 view of the Sinai Peninsula from the Nile river into Iraq. The Fayum Depression, the well-watered valley of the lower Nile, and the fertile Nile Delta are dark in contrast to the lighter orange and yellow of the surrounding desert. The boundary between the light desert and darker brush land marks the Egypt-Israel border. Other color variations are caused by differences in bedrock composition and weathering.

**Lower left: Glaciers in the Andes Mountains (STS 48-151-074)**

Although much slower as an agent of change than is running water, mountain glaciers dramatically alter the land as the ice in them slowly flows to lower elevations. Wrenching rock and soil from valley floors and walls, glaciers sculpt the land as they deposit sediment at their lower end. In this STS-48 picture, some of the most dramatic landscape in the Americas is seen. The Andes mountain range near Patagonia, Argentina is partly covered by a permanent ice cap that is part of the Los Glaciers National Park. One glacier is seen cutting off an arm of Lake Argentina (top). Water backs up behind the glacier and eventually gives way in spring in a thunderous burst that can be heard as far as 40 kilometers away.

**Lower right: Mouth of the Amazon River (STS 46-80-009)**

Though slow-moving at its mouth, the Amazon River has deposited millions of cubic meters of sediment into the Atlantic Ocean. Up river, heavy tropical rains cover the Amazon Basin and wash away thin tropical topsoil to the sea. Converting rain forest to agricultural land aggravates the erosion. The sediment plume from the river extends past the delta, built up of deposited sediment, and bends to the north to hug the coast. The plume is driven northward by the west by northwest Guyana Current. The large island of Marajo is partly visible through the widespread scattered cloud cover. The structure to the side of the picture is the remote manipulator system arm of the Shuttle orbiter.

**Space Shuttle Earth Photography**

A videodisc containing over 91,000 images of Earth taken by Space Shuttle astronauts is available for a modest charge from NASA CORE, Lorain County Joint Vocational School, 15181 Route 58 South, Oberlin, OH 44074. The images on the disk contain all Earth-looking still images taken during the STS-1 through STS-44 missions. A computer data base listing image data is available for both DOS and Macintosh formats.



National Aeronautics and  
Space Administration  
Goddard Space Flight Center

## Global Sea Surface Temperature

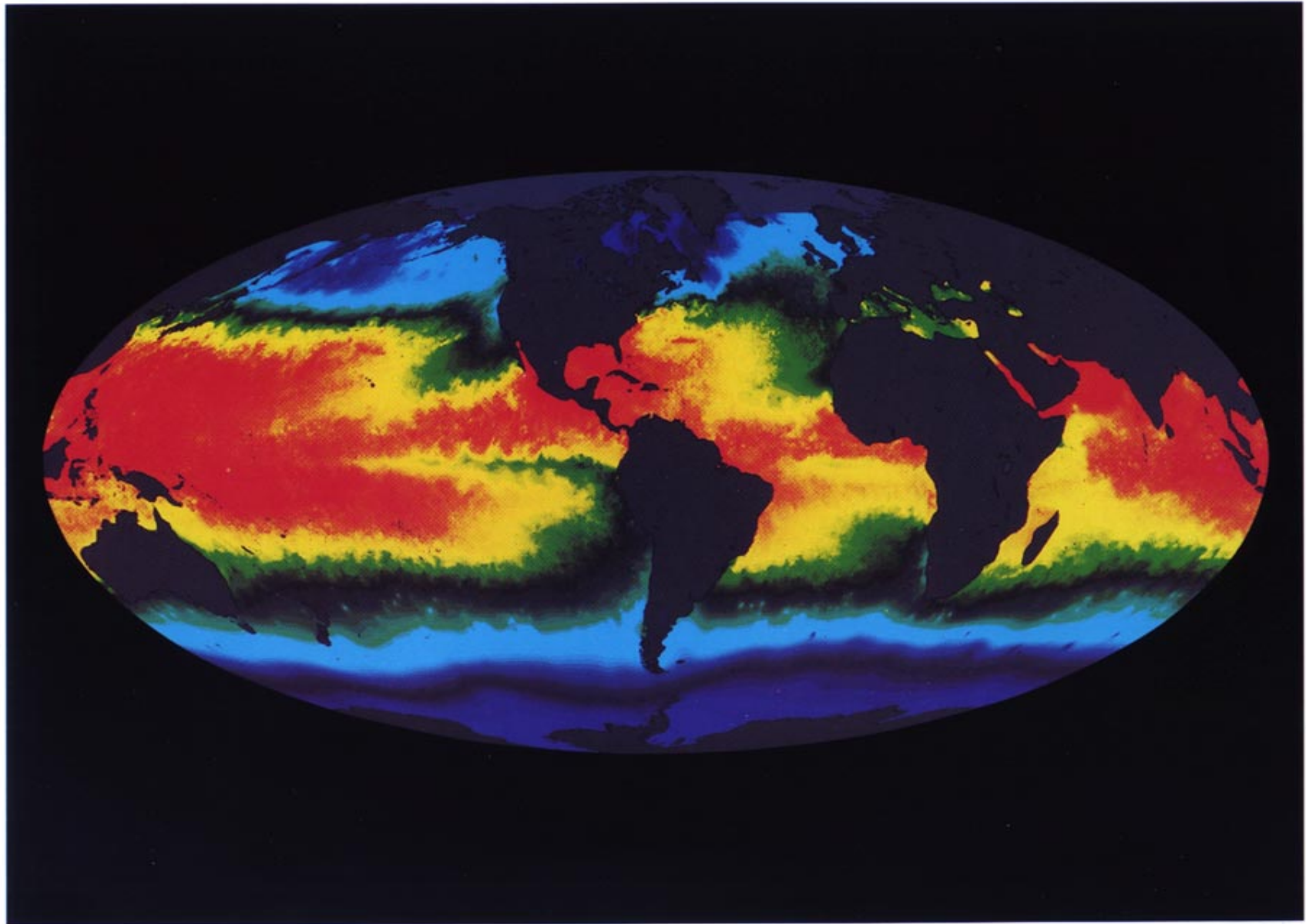



### Global Sea Surface Temperature

This illustration of Earth's sea surface temperature is part of NASA Goddard Space Flight Center's program of Earth-science research. It was obtained from two weeks of infrared observations by the Advanced Very High Resolution Radiometer (AVHRR), an instrument on board NOAA-7 during July, 1984.

Temperatures are color coded with red being warmest and decreasing through oranges, yellows, greens, and blues.

Temperature patterns seen in this image are the result of many influences including the circulation in the ocean, surface winds, and solar heating. Major ocean currents such as the Gulf Stream off the United States East Coast, the Kuroshio off the East Coast of Japan, the mixing of the Brazil and Falkland currents off the eastern coast of South America, and the Agulhas off southern Africa, appear as meandering boundaries of cool and warm waters.

The image indicates a large pool of water in the Western Pacific and a tongue of relatively cold water extending along the Equator westward from South America. Every few years, there occurs an interrelated set of changes in the global atmospheric and oceanic circulation known as an El Niño in

which the region of warm equatorial water in the west extends eastward across the Pacific and blankets the cool, productive regions along the coast of South America. Fish, birds, and marine mammals that depend upon the normally phytoplankton-rich waters often die in large numbers during El Niño.

Images of sea surface temperature such as this help scientists to better monitor and ultimately understand the changes to Earth caused by events such as El Niño.

This study is part of NASA's multiyear global research program called Mission to Planet Earth. It will use ground-based, airborne and space-based instruments to study Earth as a complete environmental system. Mission to Planet Earth is NASA's contribution to the U.S. Global Change Research Program, a multi-agency effort to understand, analyze, and predict better the effect on human activity on Earth's environment. Goddard Space Flight Center's projects for Mission to Planet Earth include: the Upper Atmosphere Research Satellite Mission; Earth Probes, such as the Tropical Rainfall Measuring Mission; the Total Ozone Mapping Spectrometer; and the most ambitious science mission ever undertaken, the Earth Observing System.

#### For the Classroom Research Topics:

- El Niño
- Upwelling
- Major ocean currents
- Mission to Planet Earth

1. Have students, individually or in teams, consult the Reader's Guide to Periodical Literature and compile a bibliography of articles dealing with different facets of Mission to Planet Earth (ocean temperatures, international cooperation, etc.).
2. John Muir, an American Naturalist, once said "When we try to pick out anything by itself, we find it hitched to everything else in the universe."

Using this statement as a writing prompt, have students explain its meaning and how it can be applied to the goal of Mission to Planet Earth.

3. Using this lithograph and a labeled world map, have the students list countries influenced by cool currents and list ways in which these countries might be affected by these currents.



National Aeronautics and  
Space Administration  
Goddard Space Flight Center

## First Image of the Global Biosphere

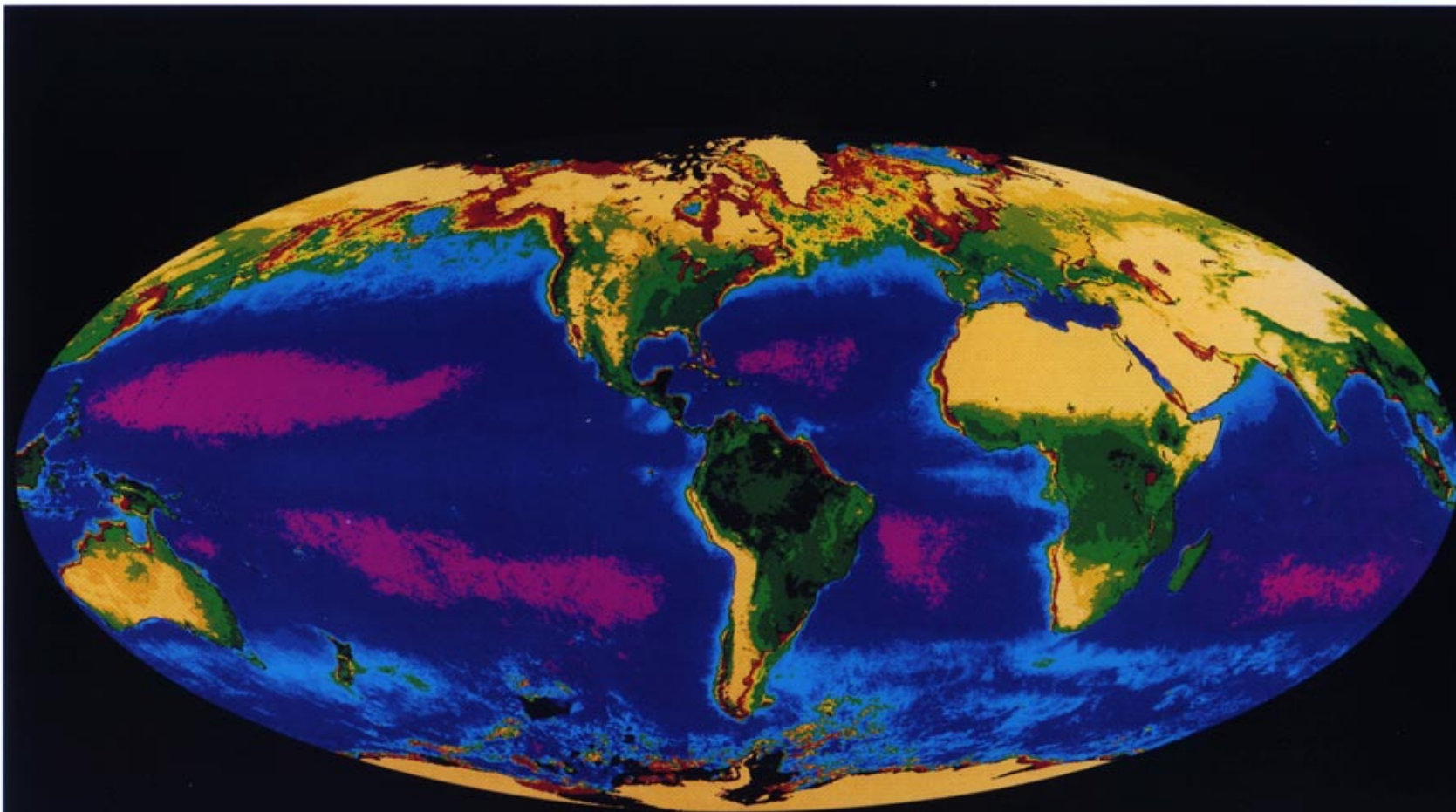

**LAND KEY:**

- Tropical forests, very productive temperature forests
- Temperature forests and moist savanna
- Dry savanna, mixed forests, grassland
- Coniferous forests, grasslands
- Semi-arid steppes and tundra
- Barren regions (desert, ice)

**OCEAN KEY:**  
Phytoplankton Pigment Concentration

High

Low



## First Image of the Global Biosphere

### First Image of the Global Biosphere

This illustration of the global biosphere is part of NASA Goddard Space Flight Center's program of Earth-science research. It shows, for the first time, the patterns of plant life both on the land and in the oceans as observed from space. The illustration was produced by combining data from two different satellites and shows Earth as a complex system, teeming with life.

#### Ocean Measurements

The ocean portion is a composite of more than 66,000 images collected between November 1978 and June 1986 by the Coastal Zone Color Scanner (CZCS), which flew on the Goddard-managed NIMBUS-7 satellite launched in October 1978. The ocean color measurements made by the CZCS indicate the distribution and abundance of phytoplankton in Earth's oceans. Phytoplankton are microscopic plants that grow in the upper sunlight regions of the ocean and are the ultimate food source for most marine life. Their uptake of carbon dioxide during photosynthesis is also a key factor in helping us to better understand the role of the oceans in the global carbon cycle.

Red and orange colors indicate areas of high concentrations. Yellow and green represent areas of moderate concentrations. Blue and violet colors represent the lowest concentrations.

The high phytoplankton concentrations along coasts and other regions where wind and currents mix the cooler, nutrient-rich waters near the surface, are often rich with fish and wildlife.

#### Land Measurements

The land vegetation image is a composite of three years of data, collected during 15,000 orbits from the Advanced Very High Resolution Radiometer (AVHRR) flown on the NOAA-7 satellite, launched in June 1981. The AVHRR measured land-surface radiation, which can be a measure of the potential for vegetation production on land.

The dark green areas (rain forests) show the highest potential for vegetation growth. The lighter shades of green highlight tropical and subtropical forests, temperate forests and farmlands, and some drier regions such as savannas and pampas. The yellow shades in the United States Midwest show lower potential. The great deserts of the world are evident as the lighter shades of yellow. The snow and ice covered regions are shown to have no productive potential in this image.

This study is part of NASA's multiyear global research program called Mission to Planet Earth that will use ground-based, airborne and space-based instruments to study Earth as a complete environmental system. Mission to Planet Earth is NASA's contribution to the U.S. Global Change Research Program, a multiagency effort to understand, analyze, and better predict the effect of human activity on Earth's environment. Goddard Space Flight Center's projects for Mission to Planet Earth include: the Upper Atmosphere Research Satellite Mission; Earth Probes, such as the Tropical Rainfall Measuring Mission; the Total Ozone Mapping Spectrometer; and the Earth Observing System, the most ambitious science mission ever undertaken.

#### For the Classroom

##### Research topics:

- Remote sensing
- Phytoplankton and their requirements
- Global carbon cycles
- El Niño
- Meteorological satellites

1. Rapid increases in phytoplankton biomass are known as "blooms." In the tropics, "blooms," are stimulated by upwelling of cool, nutrient-rich subsurface waters. "Blooms" in temperate and polar seas are caused by a different mechanism. What factor stimulates these seasonal blooms in temperate and polar seas? Remember that phytoplankton are plants and have certain requirements.

**Answer:** Amount of sunlight

2. According to the image on this lithograph, which continent has the largest percentage of tropical/temperate forests? Why is this area one of global concern? How will images such as this assist those in the study of deforestation?

**Answer:** a. South America  
b. Problems related to deforestation, global warming, etc.  
c. One way the images will assist scientists is in speeding the gathering of data regarding rates and areas of deforestation.

3. Have students create their own images by mapping the vegetation in the school area or a nearby park. Have them develop a color scale that demonstrates where vegetation is present and where it is not. You could have them get more involved by having herbaceous plants represented by a different color than woody plants.





### Viking Orbiter 1 Mars Mosaic

It has been more than 15 years since the Viking mission spacecraft first approached Mars. There were four spacecraft that made the journey to the red planet. The Viking 1 and 2 landers entered Mars's thin atmosphere and, by using parachutes and then breaking rockets, came to rest on the surface. Viking Orbiters 1 and 2 remained in orbit. Although all Viking spacecraft are now silent, the data collected by them is still providing scientists with new insights about this solar system neighbor.

Using the Planetary Image Cartography System (PICS) developed at the U.S. Geological Survey, Flagstaff, Arizona, Tammy Becker, Alfred S. McEwen, and Larry Soderblom recently processed 102 Viking Orbiter 1 images taken of Mars in 1980 to form this dramatic mosaic of nearly a full hemisphere of the planet. PICS, a computer-based system, permitted each image to be aligned with the others in a manner like fitting together the pieces of a jigsaw puzzle. Image distortions were adjusted by PICS to provide perfect border matches. To bring out detail, color variations of the dark materials were enhanced by a factor of about two and brightness variations of the images adjusted to provide consistency across the hemisphere. The view is comparable to what would be seen from a spacecraft orbiting 2,500 kilometers above the surface of the planet.

The center of the Mars mosaic shows the entire Valles Marineris, a canyon system that stretches over 3,000 kilometers in length and is up to 8 kilometers deep. The Grand Canyon of Earth compares to just one of the tributary canyons of this giant system. Layers of bright material in the eastern and central region of the canyon may be carbonate-rich sediments deposited in an ancient lake. Huge ancient river channels, such as Kasai Valles, stretch northward from the central and western regions of the canyon.

South of Valles Marineris is very ancient terrain covered by many impact craters. North of the eastern end of the Valles Marineris is the Chryse Planitia. The Viking 1 spacecraft landed in the place indicated on the sketch map.

To the west of Valles Marineris lie three of Mars's huge volcanoes. The Tharsis volcanoes, as they are known, appear as dark reddish spots. Each volcano is about 25 kilometers high, over 350 kilometers in diameter, and has a central crater at its summit. The most famous member of the Tharsis volcanoes, Olympus Mons, is not visible in the mosaic. It lies approximately 1,100 kilometers west of Ascreaeus Mons.

#### For the Classroom

1. Research the Latin roots of surface feature names on Mars such as labyrinthus, mons, planitia, and valles.
2. Learn about the life and accomplishments of Percival Lowell.
3. To visualize the size of the Martian features found on this mosaic, draw an outline of the United States on a separate piece of paper to the same scale as the mosaic. Cut out the outline and place it on the mosaic for comparison. (The distance between the central craters of Ascreaeus Mons and Pavonis Mons is approximately 700 km.)

#### References

- Carr, M. H., ed., (1984), Geology of the Terrestrial Planets, NASA SP-469, NASA Scientific and Technical information Branch, Washington, DC.
- Greeley, R. & Batson, R. M., ed., (1991), Planetary Mapping, Cambridge University Press, New York.
- NASA, (1978), The Martian Landscape, NASA SP-425, NASA Scientific and Technical information Branch, Washington, DC.
- Spitzer, G. R., ed., (1980), Viking Orbiter Views of Mars, NASA SP-441, NASA Scientific and Technical information Branch, Washington, DC.

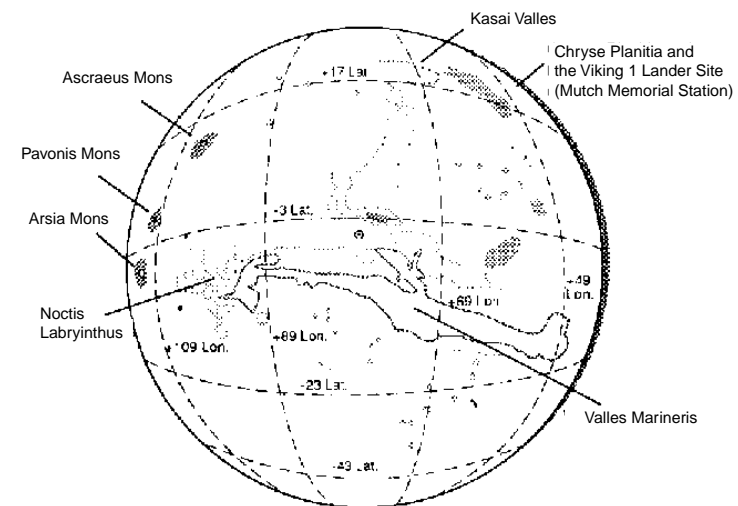



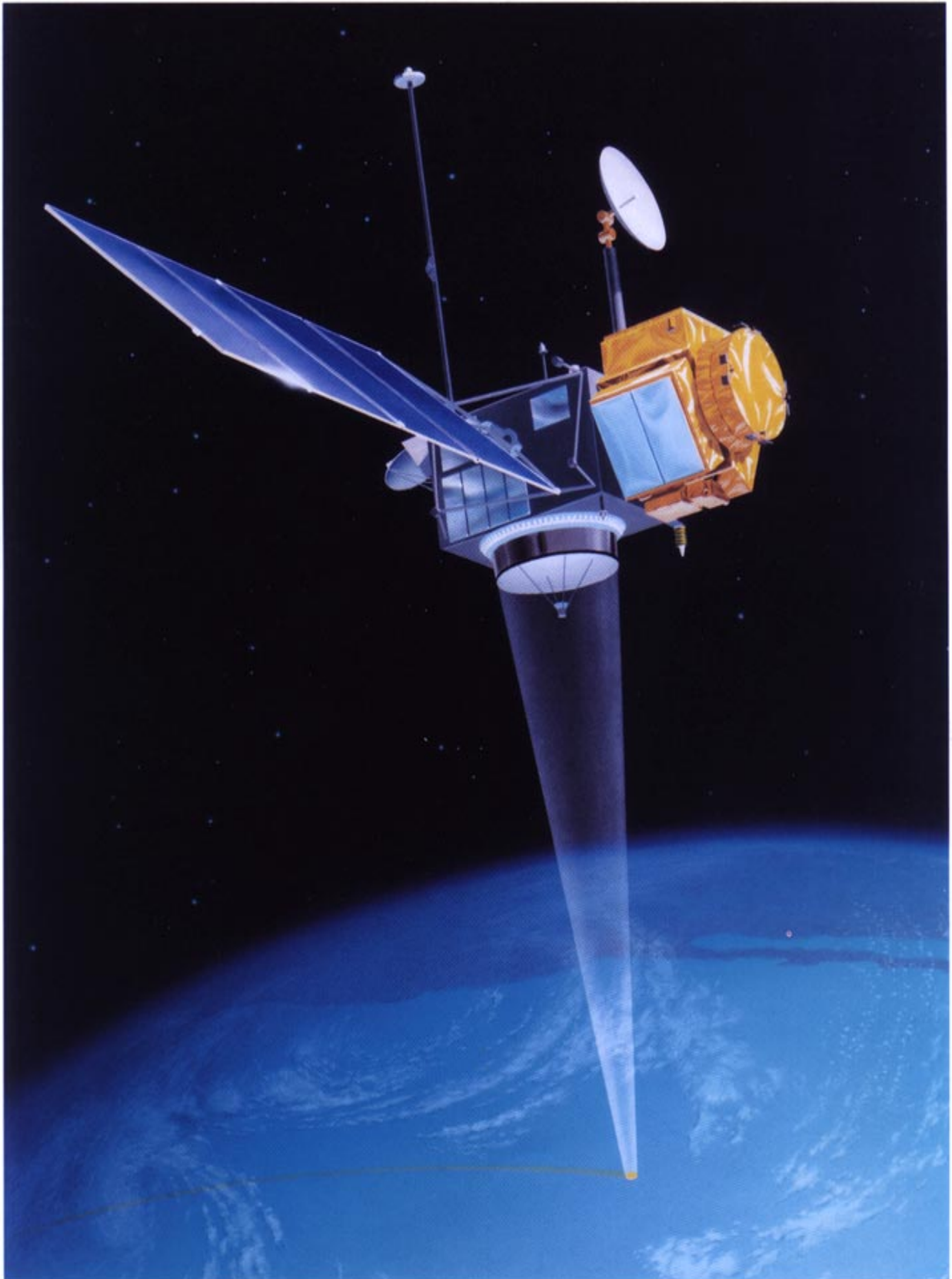



## **TOPEX/Poseidon**

The Ocean Topography Experiment (TOPEX)/Poseidon is a cooperative project between the United States and France to develop and operate an advanced satellite system dedicated to observing Earth's oceans. The mission provides global sea level measurements with an unprecedented accuracy. The data from TOPEX/Poseidon is used to determine global ocean circulation and to understand how the oceans interact with the atmosphere. This understanding improves our ability to predict global climate.

For this joint mission, the National Aeronautics and Space Administration (NASA) provided the satellite bus and five instruments with their associated ground elements. NASA's Jet Propulsion Laboratory is responsible for project management and operates and controls the satellite through NASA's Tracking and Data Relay Satellite System. The Centre Nationale d'Etudes Spatiales (CNES) furnished two instruments with their associated ground elements and dedicated a launch on an Ariane rocket. Both CNES and NASA provided precision orbit determination, and processed and distributed data to scientists from more than nine nations.

In the summer of 1992, an Ariane rocket launched TOPEX/Poseidon into orbit from the European Space Agency's Space Center located in Kourou, French Guiana. From its orbit 830 miles (1,336 kilometers) above Earth's surface, TOPEX/Poseidon makes sea level measurements along the same path every 10 days using the dual frequency altimeter developed by NASA and the CNES single frequency solid-state altimeter. This information relates changes in ocean currents with atmospheric and climate patterns.

Measurements from NASA's Microwave Radiometer provides estimates of the total water vapor content in the atmosphere, which is used to correct errors in the altimeter measurements. These combined measurements allow scientists to chart the height of the seas across ocean basins with an accuracy of 5 centimeters.

Three independent techniques determine the satellite altitude to within 5 centimeters. NASA's Laser Retroreflector Array is used with a network of 10 to 15 satellite laser ranging stations to provide the baseline tracking data for precision orbit determination and calibration of the radar altimeter bias. The DORIS system provides an alternate set of tracking data using microwave Doppler techniques. The system is composed of an onboard receiver and a network of 40 to 50 ground transmitting stations, providing all-weather global tracking of the satellite. NASA's Global Positioning System Demonstration Receiver demonstrated a new technique for precise, continuous tracking of the spacecraft.

TOPEX/Poseidon is vital part of a strategic research effort to explore ocean circulation and its interaction with the atmosphere. It was timed to coincide with and complement a number of international oceanographic and meteorological programs, including the World Circulation Experiment (WOCE) and the Tropical Ocean and Global Atmosphere (TOGA) Program, both of which are sponsored by the World Climate Research Program (WCRP). TOPEX/Poseidon will build the foundation for a continuing program of long-term observations of ocean circulation from space, and for an extensive ocean monitoring program in the next century.

# Our Mission to Planet Earth— A Guide to Teaching Earth System Science

## EDUCATOR REPLY CARD

To achieve America's goals in Educational Excellence, it is NASA's mission to develop supplementary instructional materials and curricula in science, mathematics, geography, and technology. NASA seeks to involve the educational community in the development and improvement of these materials. Your evaluation and suggestions are vital to continually improving NASA educational materials.

**Please take a moment to respond to the statements and questions below. You can submit your response through the Internet or by mail. Send your reply to the following Internet address:**

***[http://ednet.gsfc.nasa.gov/edcats/teachers\\_guide](http://ednet.gsfc.nasa.gov/edcats/teachers_guide)***

**You will then be asked to enter your data at the appropriate prompt.**

Otherwise, please return the reply card by mail. Thank you.

1. With what grades did you use the educator guide?
- Number of Teachers/Faculty:  
 \_\_\_\_\_ K-4    \_\_\_\_\_ 5-8    \_\_\_\_\_ 9-12    \_\_\_\_\_ Community College  
 College/University - \_\_\_\_\_ Undergraduate    \_\_\_\_\_ Graduate
- Number of Students:  
 \_\_\_\_\_ K-4    \_\_\_\_\_ 5-8    \_\_\_\_\_ 9-12    \_\_\_\_\_ Community College  
 College/University - \_\_\_\_\_ Undergraduate    \_\_\_\_\_ Graduate
- Number of Others:  
 \_\_\_\_\_ Administrators/Staff    \_\_\_\_\_ Parents    \_\_\_\_\_ Professional Groups  
 \_\_\_\_\_ General Public    \_\_\_\_\_ Civic Groups    \_\_\_\_\_ Other

2. What is your home 5- or 9-digit zip code? \_\_\_\_\_ — \_\_\_\_\_

3. This is a valuable educator guide?  
 Strongly Agree     Agree     Neutral     Disagree     Strongly Disagree

4. I expect to apply what I learned in this educator guide.  
 Strongly Agree     Agree     Neutral     Disagree     Strongly Disagree

Fold along line and tape closed.

5. What kind of recommendation would you make to someone who asks about this educator guide?

- Excellent     Good     Average     Poor     Very Poor

6. How did you use this educator guide?

- |  |   |
|--|---|
| <input type="checkbox"/> Background Information              | <input type="checkbox"/> Critical Thinking Tasks    |
| <input type="checkbox"/> Demonstrate NASA Materials          | <input type="checkbox"/> Demonstration              |
| <input type="checkbox"/> Group Discussions                   | <input type="checkbox"/> Hands-On Activities        |
| <input type="checkbox"/> Integration Into Existing Curricula | <input type="checkbox"/> Interdisciplinary Activity |
| <input type="checkbox"/> Lecture                             | <input type="checkbox"/> Science and Mathematics    |
| <input type="checkbox"/> Team Activities                     | <input type="checkbox"/> Standards Integration      |

Other: Please specify: \_\_\_\_\_

7. Where did you learn about this educator guide?

- NASA Educator Resource Center  
 NASA Central Operation of Resources for Educators (CORE)  
 Institution/School System  
 Fellow Educator  
 Workshop/Conference  
 Other: Please specify: \_\_\_\_\_

8. What features of this educator guide did you find particularly helpful?

\_\_\_\_\_  
 \_\_\_\_\_

9. How can we make this educator guide more effective for you?

\_\_\_\_\_  
 \_\_\_\_\_

10. Additional comments:

\_\_\_\_\_  
 \_\_\_\_\_

Today's Date: \_\_\_\_\_



Please Place  
Stamp Here  
Post Office  
Will Not Deliver  
Without Proper  
Postage

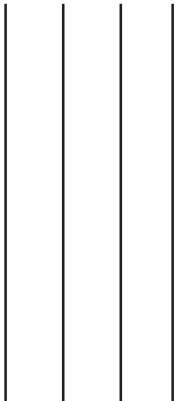

**NATIONAL AERONAUTICS AND SPACE ADMINISTRATION  
EDUCATION DIVISION  
MAIL CODE FE  
WASHINGTON DC 20546-0001**



Fold along line and tape closed.