

## Teacher Information

# Project X-35

### Objective:

To demonstrate rocketry principles through a cooperative, problem solving simulation.

### Description:

Teams simulate the development of a commercial proposal to design, build, and launch a rocket.

### Science Standards:

Science as Inquiry  
Physical Science - Position and motion of objects  
Science and Technology - Abilities of technological design  
Science in Personal and Social Perspectives -  
Science and technology in local challenges

### Science Process Skills:

Observing  
Communicating  
Measuring  
Collecting Data  
Inferring  
Predicting  
Making Models  
Interpreting Data  
Controlling Variables  
Defining Operationally  
Investigating

### Mathematics Standards:

Mathematics as Problem Solving  
Mathematics as Communication  
Mathematical Connections  
Estimation  
Number Sense and Numeration  
Whole Number Computation  
Geometry and Spatial Sense  
Measurement  
Fractions and Decimals  
Functions

### Materials and Tools:

(All supplies need to be available per group)

- 2 liter soda bottles
- 1 liter soda bottles
- Film canisters
- Aluminium soda cans
- Scrap cardboard and poster board
- Large cardboard panels
- Duct Tape
- Electrical tape
- Glue sticks
- Low-temperature glue gun
- Water
- Clay
- Plastic garbage bags
- Crepe paper
- String
- Paint
- Safety glasses
- Bottle Rocket Launcher (See page 77.)
- Altitude Calculator (See page 69.)

### Management:

Prior to this project students should have the opportunity to design, construct, and launch a bottle rocket evaluating various water volumes and air pressures and calculating the altitude traveled by these rockets. See *Bottle Rocket* page 81 and *Altitude Tracking* page 69.

This project is designed to offer students an opportunity to participate in an



interdisciplinary approach to life skills. Students work in teams of threes. Each member has designated tasks for their specific job title to help the team function effectively. These include: Project Manager, Budget Director, and Design and Launch Director. The student section provides badges and tasks.

The project takes approximately two weeks to complete and includes a daily schedule of tasks. Students may need additional time to complete daily tasks.

Collect all building materials and copy all reproducibles before beginning the activity. Be sure to make several copies of the order forms and checks for each group.

Allow enough time on the first day for the students to read and discuss all sheets and determine how they apply to the project schedule. Focus on the student score sheet to allow a clear understanding of the criteria used for assessment of the project.

### **Background Information:**

This project provides students with an exciting activity to discover practical demonstrations of force and motion in actual experiments while dealing with budgetary restraints and deadlines reflected in real life situations.

The students should have a clear understanding of rocket principles dealing with Newton's Laws of Motion found on page 13 and Practical Rocketry found on page 18 before beginning this project.

### **Procedure:**

Refer to the student sheets. The events for day 3 and day 6 call for teacher demonstrations on how to make nose cones and how to determine the center of mass and the center of pressure.

### **Assessment:**

Assessment will be based on documentation of three designated areas: each group's project journal, silhouette, and launch results. See Student Score Sheet for details.

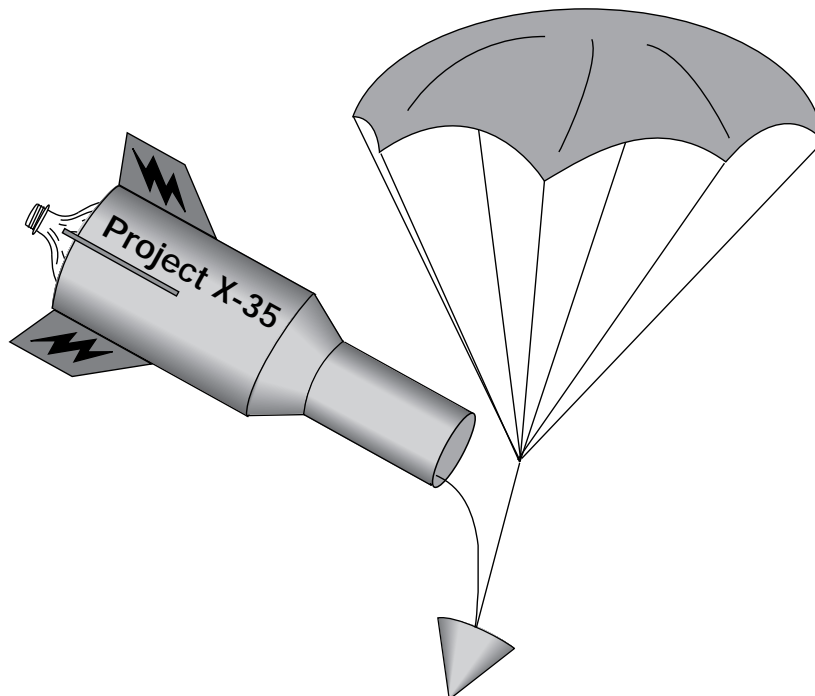

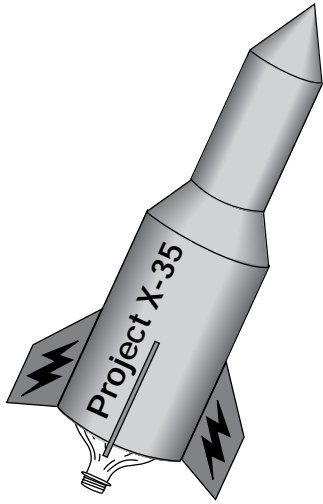

# Request For Proposals

The United Federation of Planets (UFP) is seeking competitive bids for a new advanced rocket launch vehicle that will reduce the costs of launching payloads into Earth orbit. Interested companies are invited to submit proposals to UFP for designing and building a rocket that will meet the following criteria.

## The objectives of Project X-35 are:

- a. Design and draw a bottle rocket plan to scale (1 square = 2 cm).
- b. Develop a budget for the project and stay within the budget allowed.
- c. Build a test rocket using the budget and plans developed by your team.
- d. Identify rocket specifications and evaluate rocket stability by determining center of mass and center of pressure and conducting a swing test.
- e. Display fully illustrated rocket design in class. Include: dimensional information, location of center of mass, center of pressure, and flight information such as time aloft and altitude reached.
- f. Successfully test launch rocket achieving maximum vertical distance and accuracy.
- g. Successfully and accurately complete rocket journal.
- h. Develop a cost analysis and demonstrate the most economically efficient launch.

## Proposal Deadline:

Two (2) weeks



# Project Schedule

Project X-35 Schedule

## Day 1

- Form rocket companies.
- Brainstorm ideas for design and budget.
- Sketch preliminary rocket design.

Project X-35 Schedule

## Day 2

- Develop materials and budget list.
- Develop scale drawing.

Project X-35 Schedule

## Day 3

- Demonstration: nose cone construction.
- Issue materials and begin construction.

Project X-35 Schedule

## Day 4

- Continue construction.

Project X-35 Schedule

## Day 5

- Complete construction.

Project X-35 Schedule

## Day 6

- Demonstration: Find center of mass and center of pressure.
- Introduce rocket silhouette construction and begin rocket analysis.

Project X-35 Schedule

## Day 7

- Finish silhouette construction and complete prelaunch analysis. Hang silhouette.
- Perform swing test.

Project X-35 Schedule

## Day 8

- Launch Day!

Project X-35 Schedule

## Day 9

- Complete post launch results, silhouette documentation.
- Prepare journal for collection.
- Documentation and journal due at beginning of class tomorrow.



# Project X-35 Checklist

## Project Grading:

50% Documentation: See Project Journal below. Must be complete, neat, accurate, and on time.

25% Proper display and documentation of rocket silhouette.

25% Launch data: Measurements, accuracy, and completeness.

## Project Awards:

UFP will award exploration contracts to the companies with the top three rockets designs based on the above criteria. The awards are valued at:

First - \$10,000,000

Second - \$5,000,000

Third - \$3,000,000

## Project Journal: Check off items as you complete them.

- 1. Creative cover with member's names, date, project number, and company name.
- 2. Certificate of Assumed Name (Name of your business)
- 3. Scale drawing of rocket plans. Clearly indicate scale. Label: Top, Side, and End View.
- 4. Budget Projection
- 5. Balance Sheet
- 6. Canceled checks, staple or tape checks in ascending numerical order, four to a sheet of paper.
- 7. Pre-Launch Analysis
- 8. Rocket Launch Day Log
- 9. Score Sheet (Complete part 3.)



## Badges

Each group member will be assigned specific tasks to help their team function successfully. All team members assist with design, construction, launch, and paper work. Enlarge the badges and glue them front and back to poster board. Cut out the slot and attach a string.



# X-35

## Project Manager

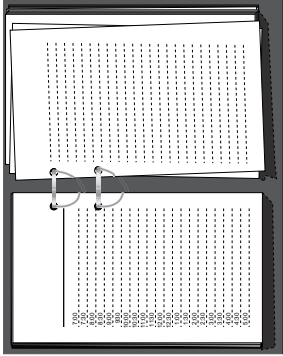



Oversees the project. Keeps others on task. Only person who can communicate with teacher.

- Arrange all canceled checks in ascending numerical order. Make a neat copy of the team's Rocket Journal.
- Use appropriate labels as necessary.
- Check over balance sheet. List all materials used in rocket construction.
- Complete silhouette information and display properly in room.
- Assist other team members as needed.



# X-35

## Design and Launch Director

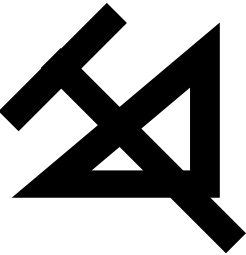



Supervises design and construction of rocket. Directs others during launch.

- Make a neat copy of the Launch Day Log.
- Use appropriate labels as necessary.
- Arrange to have a creative cover made.
- Assist other team members as needed.



# X-35

## Budget Director





Keeps accurate account of money and expenses and pays bills. Must sign all checks.

- Arrange all canceled checks in order and staple four to a sheet of paper.
- Check over budget projection sheet. Be sure to show total project cost estimates.
- Check over balance sheet. Be sure columns are complete and indicate a positive or negative balance.
- Complete part 3 of the score sheet.
- Assist other team members as needed.

### Badge Front

### Badge Back



State of \_\_\_\_\_

# Certificate of Assumed Name

All Information on this form is public information.  
Please type or print legibly in black ink.

Project Number \_\_\_\_\_

1. State the exact assumed name under which the business is or will be conducted:

\_\_\_\_\_

2. List the name and title of all persons conducting business under the above assumed name:

\_\_\_\_\_

\_\_\_\_\_

\_\_\_\_\_

\_\_\_\_\_

Today's Date \_\_\_\_\_, 19\_\_\_\_ Class Hour \_\_\_\_\_

Filling Fee: a \$25 fee must accompany this form.



# Project X-35 Budget

Each team will be given a budget of \$1,000,000. Use money wisely and keep accurate records of all expenditures. Once your money runs out, you will operate in the "red" and this will count against your team score. If you are broke at the time of launch, you will be unable to purchase rocket fuel. You will then be forced to launch only with compressed air. You may only purchase as much rocket fuel as you can afford at the time of launch.

All materials not purchased from listed subcontractors will be assessed an import duty tax, 20% of the market value. Materials not on the subcontractors list will be assessed an Originality Tax of \$5,000.00 per item.

A project delay penalty fee will be assessed for not working, lacking materials, etc. This penalty fee could be as high as \$300,000 per day.

## Approved Subcontractor List

SubContractor		Market Price
Bottle Engine Corporation		
	2 L bottle	\$200,000
	1 L bottle	\$150,000
Aluminum Cans Ltd.		
	Can	\$ 50,000
International Paper Corporation		
	Cardboard - 1 sheet	\$ 25,000
	Tagboard - 1 sheet	\$ 30,000
	Manila Paper - 1 sheet	\$ 40,000
	Silhouette Panel - 1 sheet	\$100,000
International Tape and Glue Company		
	Duct Tape - 50 cm segments	\$ 50,000
	Electrical Tape - 100 cm segments	\$ 50,000
	Glue Stick	\$ 20,000
Aqua Rocket Fuel Service		
	1 ml	\$ 300
Strings, Inc.		
	1 m	\$ 5,000
Plastic Sheet Goods		
	1 bag	\$ 5,000
Common Earth Corporation		
	Modeling Clay - 100 g	\$ 5,000
NASA Launch Port	Launch	\$100,000
NASA Consultation	Question	\$1,000





# Project X-35

# Order Form

Company Name: \_\_\_\_\_

Check No. \_\_\_\_\_ Budget Director's Signature \_\_\_\_\_

Date \_\_\_\_\_ Supply Company Name \_\_\_\_\_

Item Ordered	Quantity	Unit Cost	Total Cost
		_____	_____

# Project X-35

# Order Form

Company Name: \_\_\_\_\_

Check No. \_\_\_\_\_ Budget Director's Signature \_\_\_\_\_

Date \_\_\_\_\_ Supply Company Name \_\_\_\_\_

Item Ordered	Quantity	Unit Cost	Total Cost
		_____	_____

# Project X-35

# Order Form

Company Name: \_\_\_\_\_

Check No. \_\_\_\_\_ Budget Director's Signature \_\_\_\_\_

Date \_\_\_\_\_ Supply Company Name \_\_\_\_\_

Item Ordered	Quantity	Unit Cost	Total Cost
		_____	_____

# Project X-35

# Order Form

Company Name: \_\_\_\_\_

Check No. \_\_\_\_\_ Budget Director's Signature \_\_\_\_\_

Date \_\_\_\_\_ Supply Company Name \_\_\_\_\_

Item Ordered	Quantity	Unit Cost	Total Cost
		_____	_____



# Project X-35 Budget Projection

Company Name \_\_\_\_\_

Record below all expenses your company expects to incur in the design, construction, and launch of your rocket.

Item	Supplier	Quantity	Unit Cost	Total Cost
			_____.	_____.
			_____.	_____.
			_____.	_____.
			_____.	_____.
			_____.	_____.
			_____.	_____.
			_____.	_____.
			_____.	_____.
			_____.	_____.
			_____.	_____.
			_____.	_____.
			_____.	_____.
<b>Projected Total Cost</b>				_____.



Keep This Stub For Your Records Check No. _____ Date _____, 19____ To _____ For _____ Amount \$ <input type="text"/>	Detach on Dashed Lines	<b>Company Name:</b> _____	Check No. _____
		Pay to the order of _____	Date _____, 19____
		For _____	\$ <input type="text"/>
		For _____	Dollars _____
		_____	Authorized Signature _____
		Budget Director's Signature _____	

Keep This Stub For Your Records Check No. _____ Date _____, 19____ To _____ For _____ Amount \$ <input type="text"/>	Detach on Dashed Lines	<b>Company Name:</b> _____	Check No. _____
		Pay to the order of _____	Date _____, 19____
		For _____	\$ <input type="text"/>
		For _____	Dollars _____
		_____	Authorized Signature _____
		Budget Director's Signature _____	

Keep This Stub For Your Records Check No. _____ Date _____, 19____ To _____ For _____ Amount \$ <input type="text"/>	Detach on Dashed Lines	<b>Company Name:</b> _____	Check No. _____
		Pay to the order of _____	Date _____, 19____
		For _____	\$ <input type="text"/>
		For _____	Dollars _____
		_____	Authorized Signature _____
		Budget Director's Signature _____	

Keep This Stub For Your Records Check No. _____ Date _____, 19____ To _____ For _____ Amount \$ <input type="text"/>	Detach on Dashed Lines	<b>Company Name:</b> _____	Check No. _____
		Pay to the order of _____	Date _____, 19____
		For _____	\$ <input type="text"/>
		For _____	Dollars _____
		_____	Authorized Signature _____
		Budget Director's Signature _____	



# Project X-35 Balance Sheet

Company Name \_\_\_\_\_

Check No.	Date	To	Amount	Balance
			_____.	_____.
			_____.	_____.
			_____.	_____.
			_____.	_____.
			_____.	_____.
			_____.	_____.
			_____.	_____.
			_____.	_____.
			_____.	_____.
			_____.	_____.
			_____.	_____.
			_____.	_____.
			_____.	_____.
			_____.	_____.
			_____.	_____.
			_____.	_____.
			_____.	_____.
			_____.	_____.
			_____.	_____.
			_____.	_____.
			_____.	_____.
			_____.	_____.
			_____.	_____.
			_____.	_____.



# Rocket Measurements For Scale Drawing

Project No. \_\_\_\_\_

Date \_\_\_\_\_

Company Name \_\_\_\_\_

Use metric measurements to measure and record the data in the blanks below. Be sure to accurately measure all objects that are constant (such as the bottles) and those you will control (like the size and design of fins). If additional data lines are needed, use the back of this sheet.

Object	Length	Width	Diameter	Circumference

Using graph paper draw a side, top, and bottom view of your rocket, to scale (1 square = 2 cm), based on the measurements recorded above. Attach your drawings to this paper.



# Scale Drawing

1 square = 2 cm

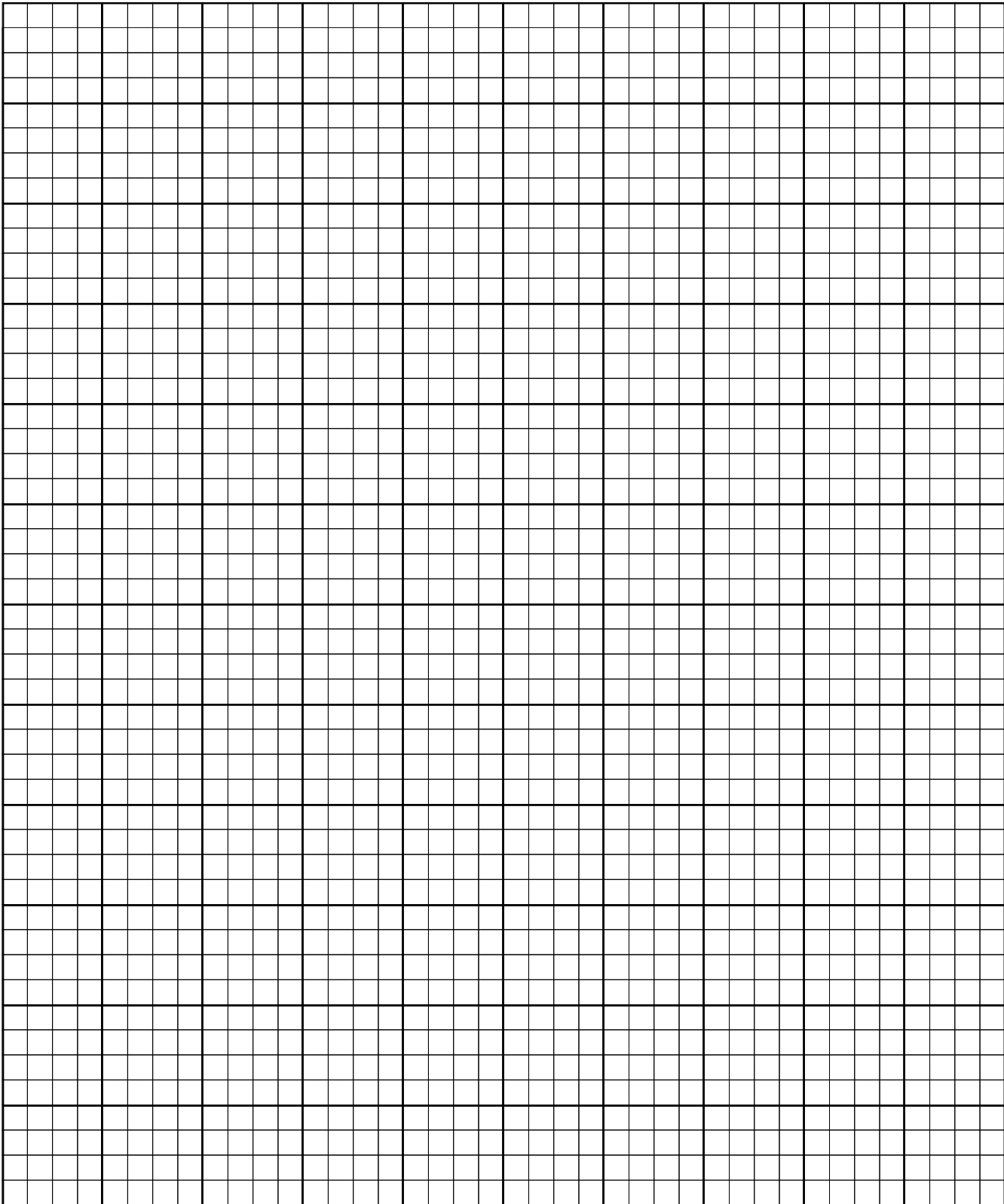

# Rocket Stability Determination

A rocket that flies straight through the air is said to be a *stable* rocket. A rocket that veers off course or tumbles wildly is said to be an *unstable* rocket. The difference between the flight of a stable and unstable rocket depends upon its design. All rockets have two distinct "centers." The first is the *center of mass*. This is a point about which the rocket balances. If you could place a ruler edge under this point, the rocket would balance horizontally like a seesaw. What this means is that half of the mass of the rocket is on one side of the ruler edge and half is on the other. Center of mass is important to a rocket's design because if a rocket is unstable, the rocket will tumble about this center.

The other center in a rocket is the *center of pressure*. This is a point where half of the surface area of a rocket is on one side and half is on the other. The center of pressure differs from center of mass in that its location is not affected by the placement of payloads in the rocket. This is just a point based on the surface of the rocket, not what is inside. During flight, the pressure of air rushing past the rocket will balance half on one side of this point and half on the other. You can determine the center of pressure by cutting out an exact silhouette of the rocket from cardboard and balancing it on a ruler edge.

The positioning of the center of mass and the center of pressure on a rocket is critical to its stability. The center of mass should be towards the rocket's nose and the center of pressure should be towards the rocket's tail for the rocket to fly straight. That is because the lower end of the rocket (starting with the center of mass and going downward) has more surface area than the upper end (starting with the center of mass and going upward). When the rocket flies, more air pressure exists on the lower end of the rocket than on the upper end. Air pressure will keep the lower end down and the upper end up. If the center of mass and the center of pressure are in the same place, neither end of the rocket will point upward. The rocket will be unstable and tumble.

## Stability Determination Instructions

1. Tie a string loop around the middle of your rocket. Tie a second string to the first so that you can pick it up. Slide the string loop to a position where the rocket balances. You may have to temporarily tape the nose cone in place to keep it from falling off.
2. Draw a straight line across the scale diagram of the rocket you made earlier to show where the ruler's position is. Mark the middle of the line with a dot. This is the rocket's center of mass.
3. Lay your rocket on a piece of cardboard. Carefully trace the rocket on the cardboard and cut it out.

4. Lay the cardboard silhouette you just cut out on the ruler and balance it.
5. Draw a straight line across the diagram of your rocket where the ruler is. Mark the middle of this line with a dot. This is the center of pressure of the rocket.

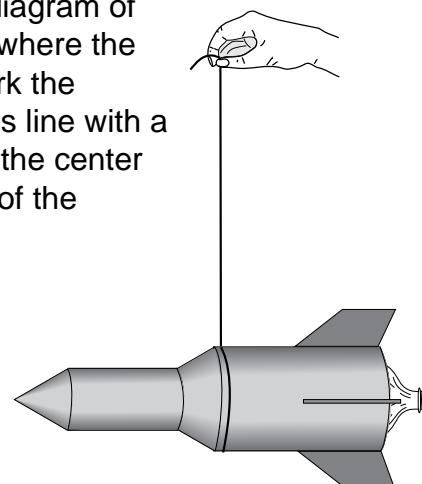

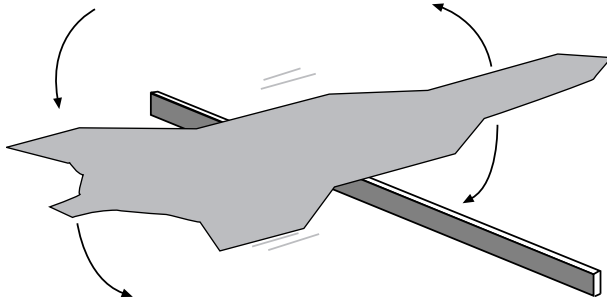

If your center of mass is in front of the center of pressure, your rocket should be stable. Proceed to the swing test. If the two centers are next to or on top of each other, add more clay to the nosecone of the rocket. This will move the center of mass forward. Repeat steps 2 and 3 and then proceed to the swing test.

**Swing Test:**

1. Tape the string loop you tied around your rocket in the previous set of instructions so that it does not slip.
2. While standing in an open place, slowly begin swinging your rocket in a circle. If the rocket points in the direction you are swinging it, the rocket is stable. If not, add more clay to the rocket nose cone or replace the rocket fins with larger ones. Repeat the stability determination instructions and then repeat the swing test.

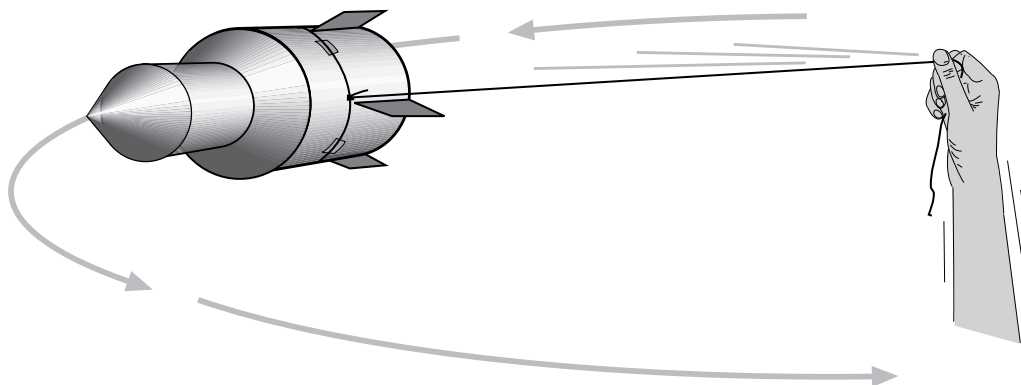
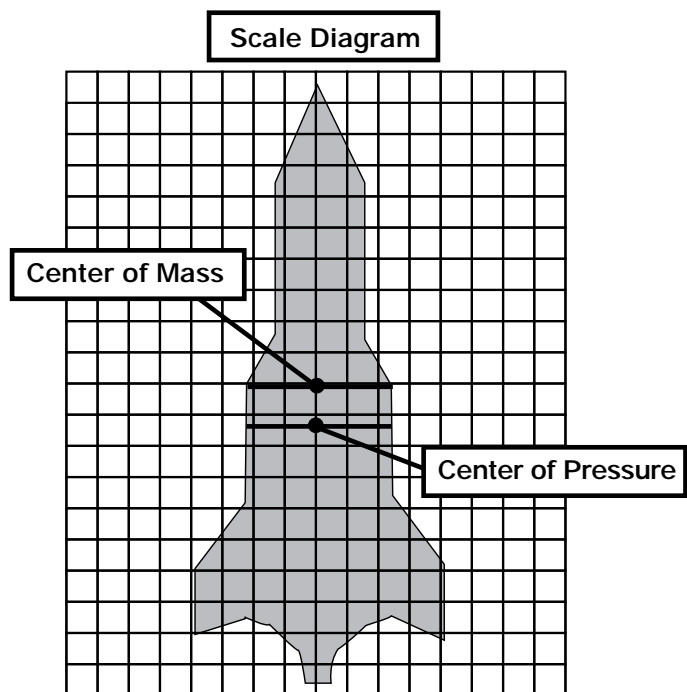



# Pre-Launch Analysis

Company Name: \_\_\_\_\_ Project Number:

Employee Name: \_\_\_\_\_

Job Title: \_\_\_\_\_

Employee Name: \_\_\_\_\_

Job Title: \_\_\_\_\_

Employee Name: \_\_\_\_\_

Job Title: \_\_\_\_\_

## Rocket Specifications

Total Mass: \_\_\_\_\_ g

Number of Fins: \_\_\_\_\_

Total Length: \_\_\_\_\_ cm

Length of Nose Cone: \_\_\_\_\_ cm

Width (widest part): \_\_\_\_\_ cm

Volume of Rocket Fuel (H<sub>2</sub>O) to be used on

Circumference: \_\_\_\_\_ cm

Launch Day: \_\_\_\_\_ ml, \_\_\_\_\_ L

## Rocket Stability

### Center of Mass (CM)

Distance from Nose: \_\_\_\_\_ cm

Distance from Tail: \_\_\_\_\_ cm

Distance of CM from CP: \_\_\_\_\_ cm

Did your rocket pass the swing test? \_\_\_\_\_

### Center of Pressure (CP)

Distance from Nose: \_\_\_\_\_ cm

Distance from Tail: \_\_\_\_\_ cm



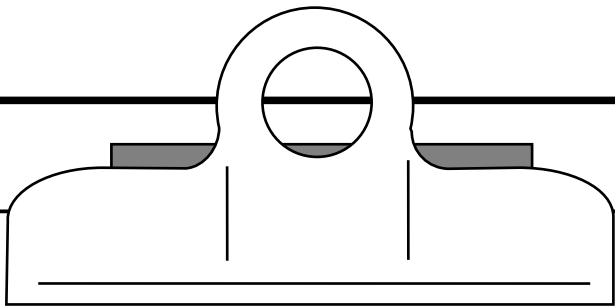

# Flight Day Log

Date: \_\_\_\_\_

Time: \_\_\_\_\_

Project No.

Company Name: \_\_\_\_\_

Launch Director: \_\_\_\_\_

Weather Conditions: \_\_\_\_\_

\_\_\_\_\_

Wind Speed: \_\_\_\_\_ Wind Direction: \_\_\_\_\_

Air Temperature: \_\_\_\_\_ °C

Launch Location: \_\_\_\_\_

Launch Angle (degrees): \_\_\_\_\_ Launch Direction: \_\_\_\_\_

Fuel (water) volume: \_\_\_\_\_ mL \_\_\_\_\_ L

Flight Altitude: \_\_\_\_\_ M

Evaluate your rocket's performance:

Recommendations for future flights:



# Project X-35 Score Sheet

TOTAL SCORE:

Project No. \_\_\_\_\_

Date \_\_\_\_\_

Company Name \_\_\_\_\_

## Part I: Documentation: 50% of project grade

---

Neatness \_\_\_\_\_ Completeness \_\_\_\_\_

Accuracy \_\_\_\_\_ Order \_\_\_\_\_

On time \_\_\_\_\_

SCORE:

## Part II: Silhouette: 25% of project grade

---

Neatness \_\_\_\_\_ Completeness \_\_\_\_\_

Accuracy \_\_\_\_\_ Proper balance \_\_\_\_\_

Correct use of labels \_\_\_\_\_

SCORE:

## Part III: Launch Results: 25% of project grade (teams complete this section)

---

a. Rocket Altitude \_\_\_\_\_ Rank \_\_\_\_\_

b. Expenditures and Penalty Fees \_\_\_\_\_  
(Check total from Balance Sheet)

c. Investment and Penalty Fees \_\_\_\_\_  
(Total check amount column on Balance Sheet)

d. Final Balance \_\_\_\_\_  
(New Balance on Balance Sheet)

e. Efficiency (Cost/Meter) \_\_\_\_\_  
(Divide Investment (b) by Rocket Altitude (a) )

f. Contract Award \_\_\_\_\_

g. Profit \_\_\_\_\_  
(Contract Award (f) minus Investment (c) )

SCORE:

