

The Session Initiation Protocol (SIP)

Henning Schulzrinne
Dept. of Computer Science
Columbia University
New York, New York
(sip:)schulzrinne@cs.columbia.edu

Overview

- protocol architecture
- typical component architectures
- addressing and locating SIP entities
- protocol operation and extensions
- reliability
- services, features and caller preferences
- security and QoS
- programming SIP services

Introduction

- SIP = core protocol for establishing *sessions* in the Internet
- transports session description information from initiator (caller) to callees
- allows to change parameters in mid-session
- terminate session

VoIP protocol architecture

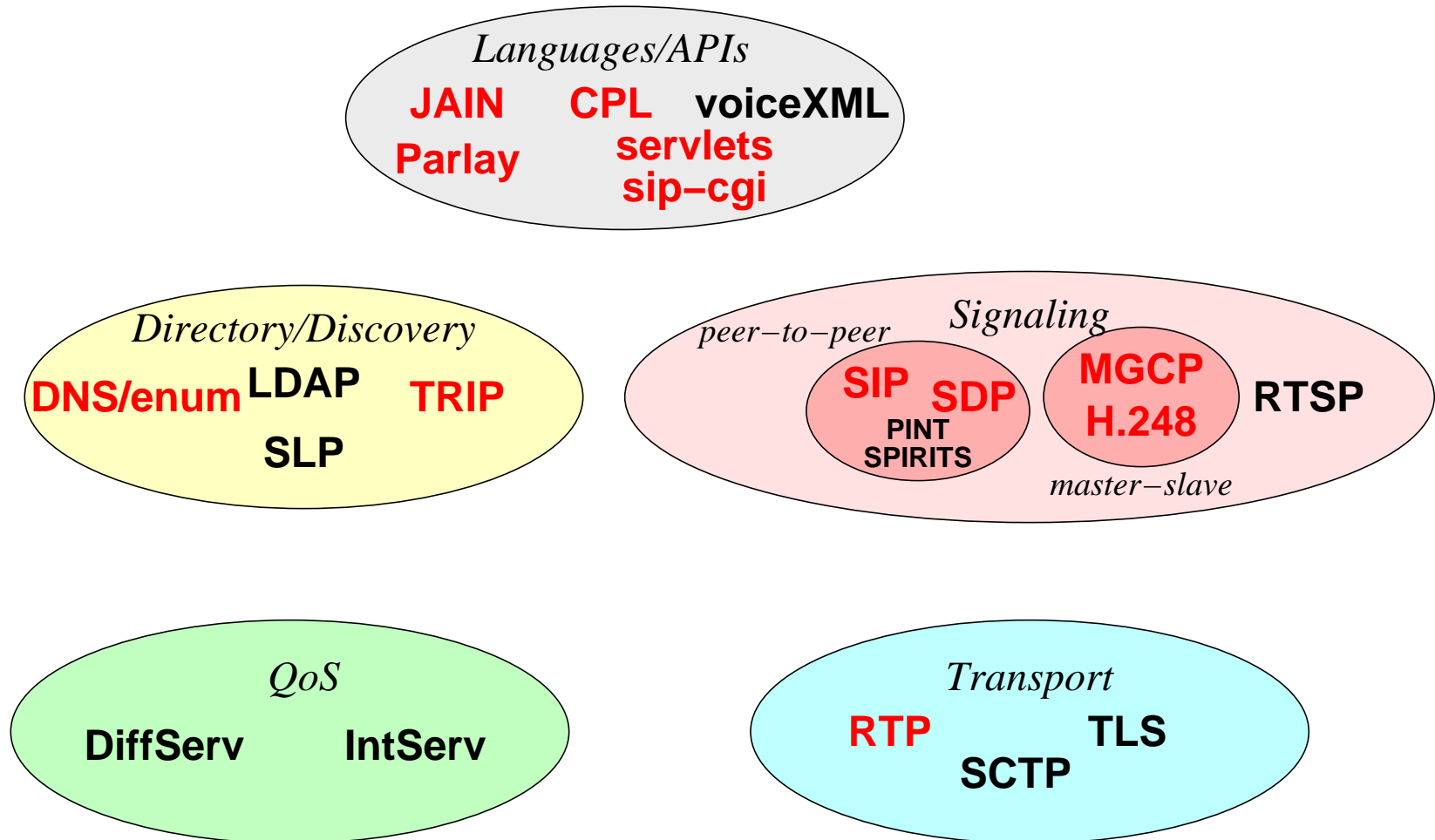

Multimedia protocol stack

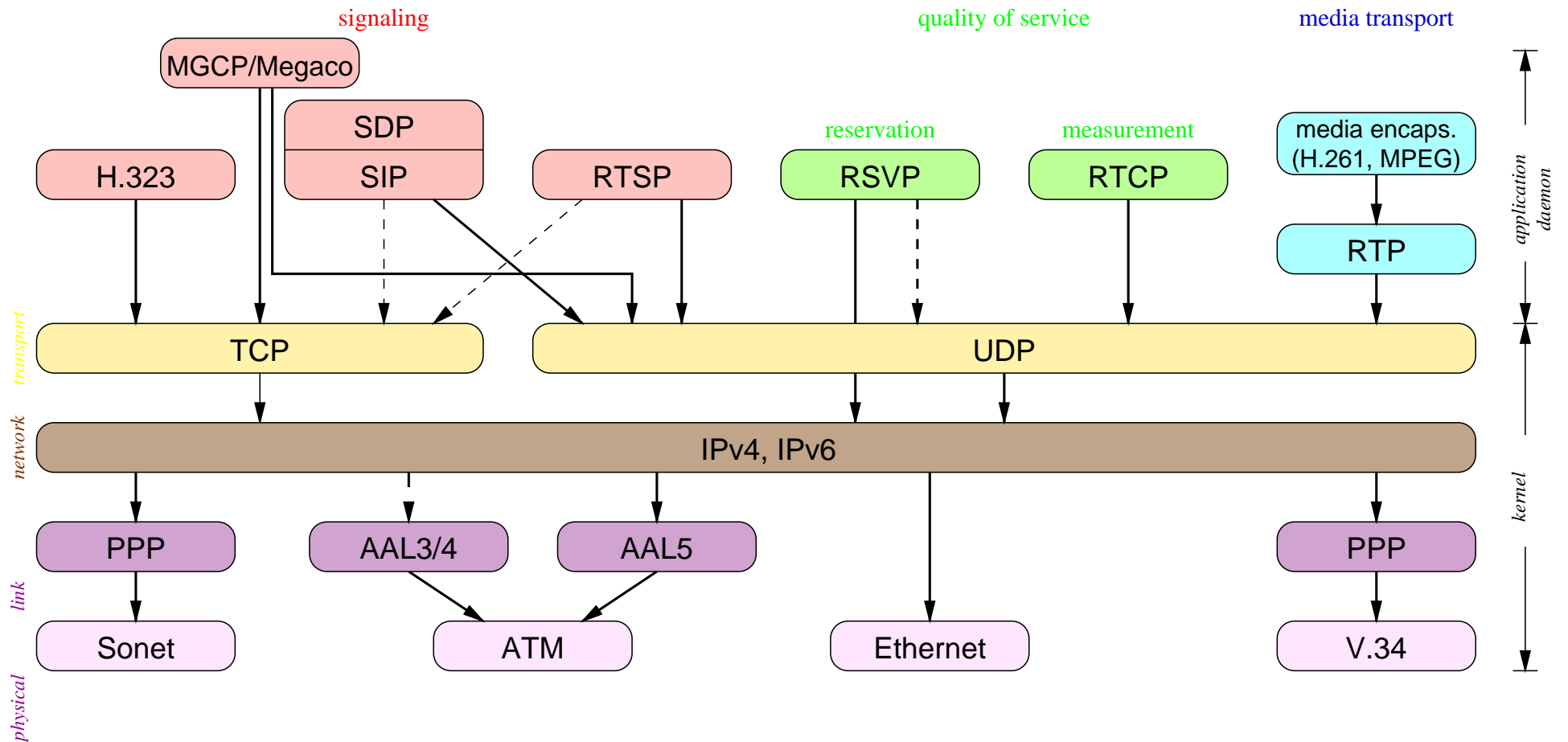

SIP protocol use

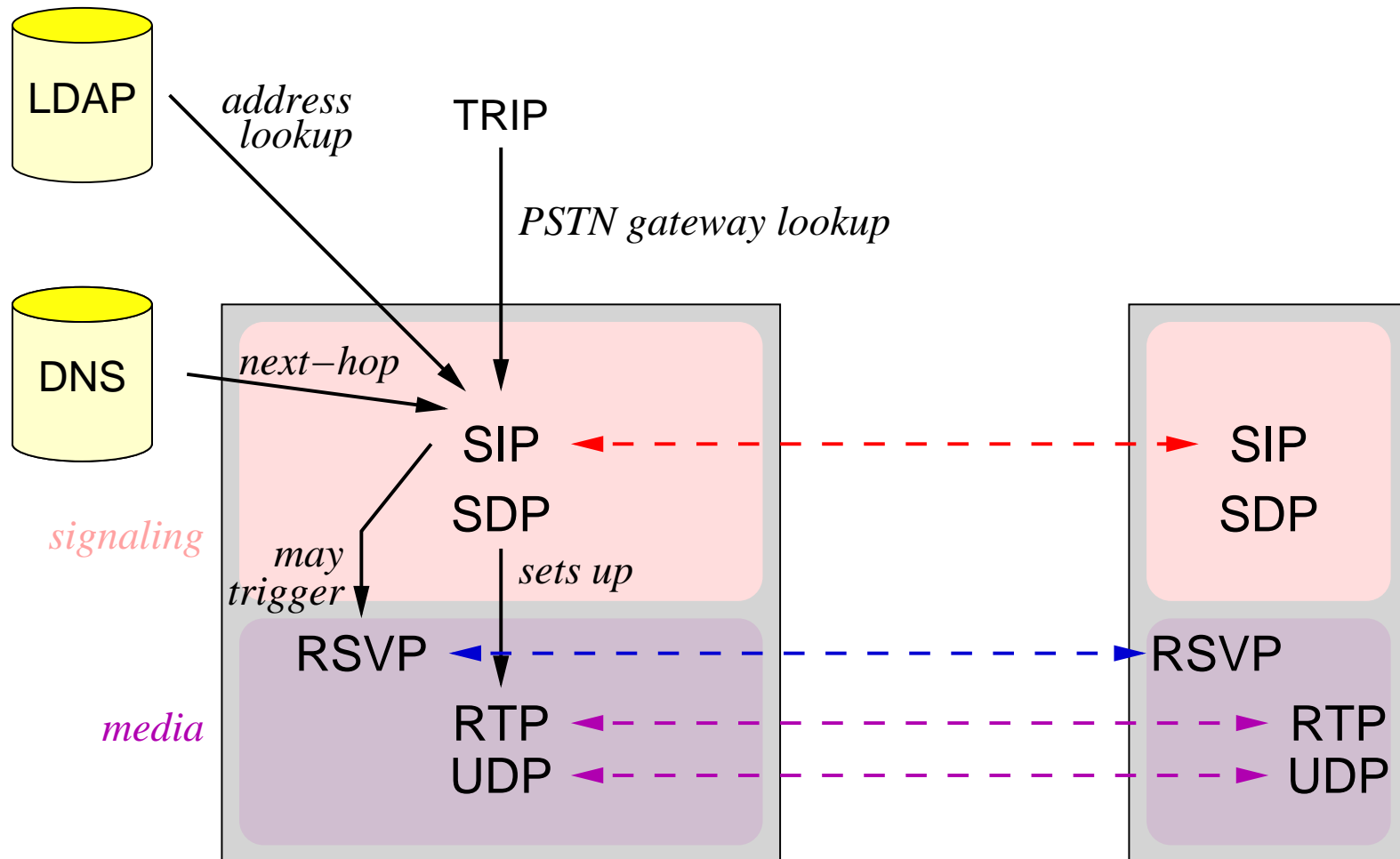

SIP applications

- setting up voice-over-IP calls
- setting up multimedia conferences
- event notification (subscribe/notify) ⇨ IM and presence
- text and general messaging
- signaling transport

SIP addressing

Personal mobility

SIP uses email-style addresses to identify users

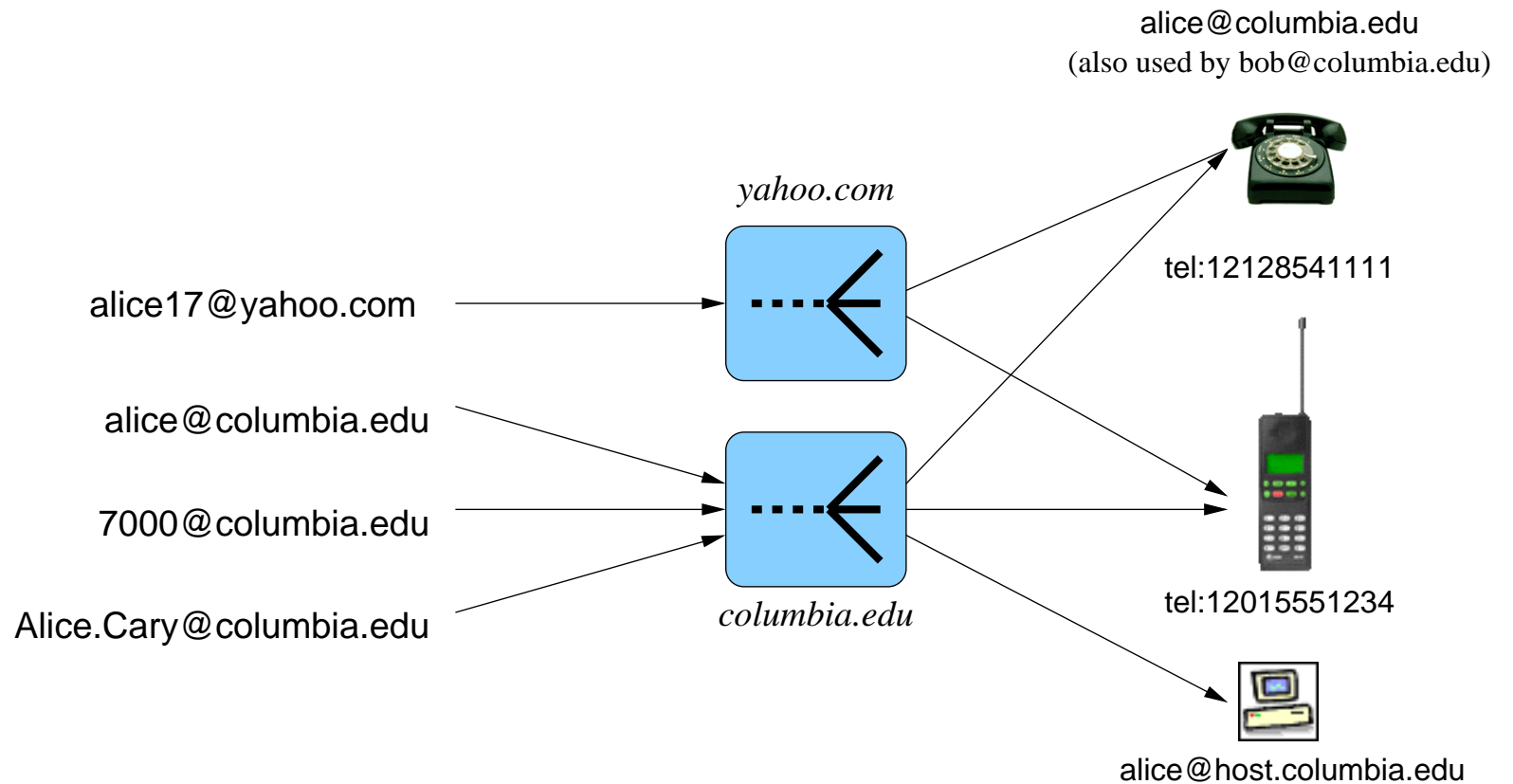

SIP addressing

- typically, same as user's email address:

`alice@example.com`

`12125551212@gateways-r-us.com`

- written as URL, e.g., `sip:alice@example.com`
- can add parameters, such as type (`user="phone"`) or transport protocol

tel URLs (RFC 2806)

- also can use tel URLs for telephone numbers, e.g., `tel:+12125551212` or `fax:+358.555.1234567`
- either global (`tel:+1...`) or local (`tel:0w003585551234567;phone-context=+3585551234` numbers)
- allow post-dialing digits: `;postd=pp32`
- also `modem:+3585551234567;type=v32b?7e1;type=v110`

SIP building blocks

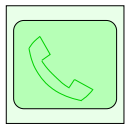

SIP user agent

IP phone, PC, conference bridge

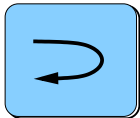

SIP redirect server

returns new location for requests



SIP stateless proxy

routes call requests

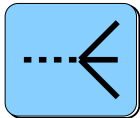

SIP (forking) proxy

routes call requests

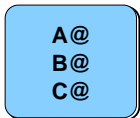

SIP registrar

maintains mappings from names to addresses

Back-to-back UA (B2BUA)

- two (or more) user agents, where incoming calls trigger outgoing calls to somebody else
- also, “third-party call control” (later)
- useful for services and anonymity

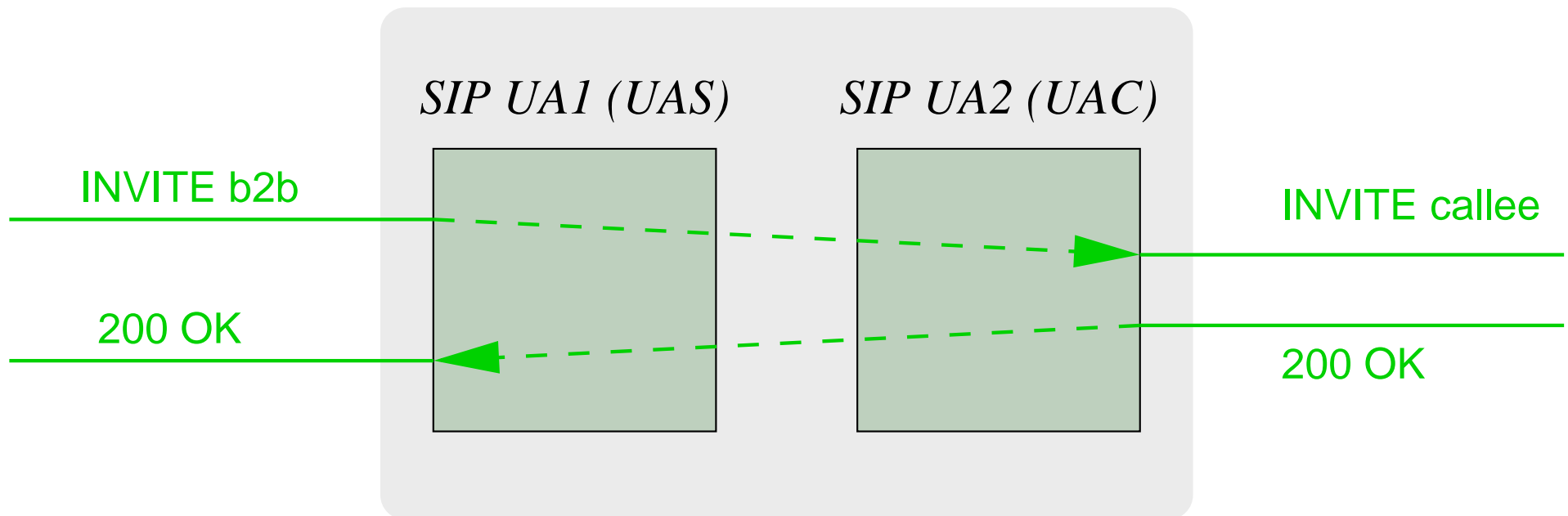

Maintaining state in SIP entities

Stateless: each request and response handled independently

(Transaction) stateful: remember a whole request/response *transaction*

Call stateful: remember a call from beginning to end

SIP building block properties

	media	stateless	stateful	call state
UA (UAC, UAS)	yes	no	unlikely	common
proxy	no	yes	common	possible (firewall)
redirect registrar	no	no	yes	N/A

SIP architecture: peer-to-peer

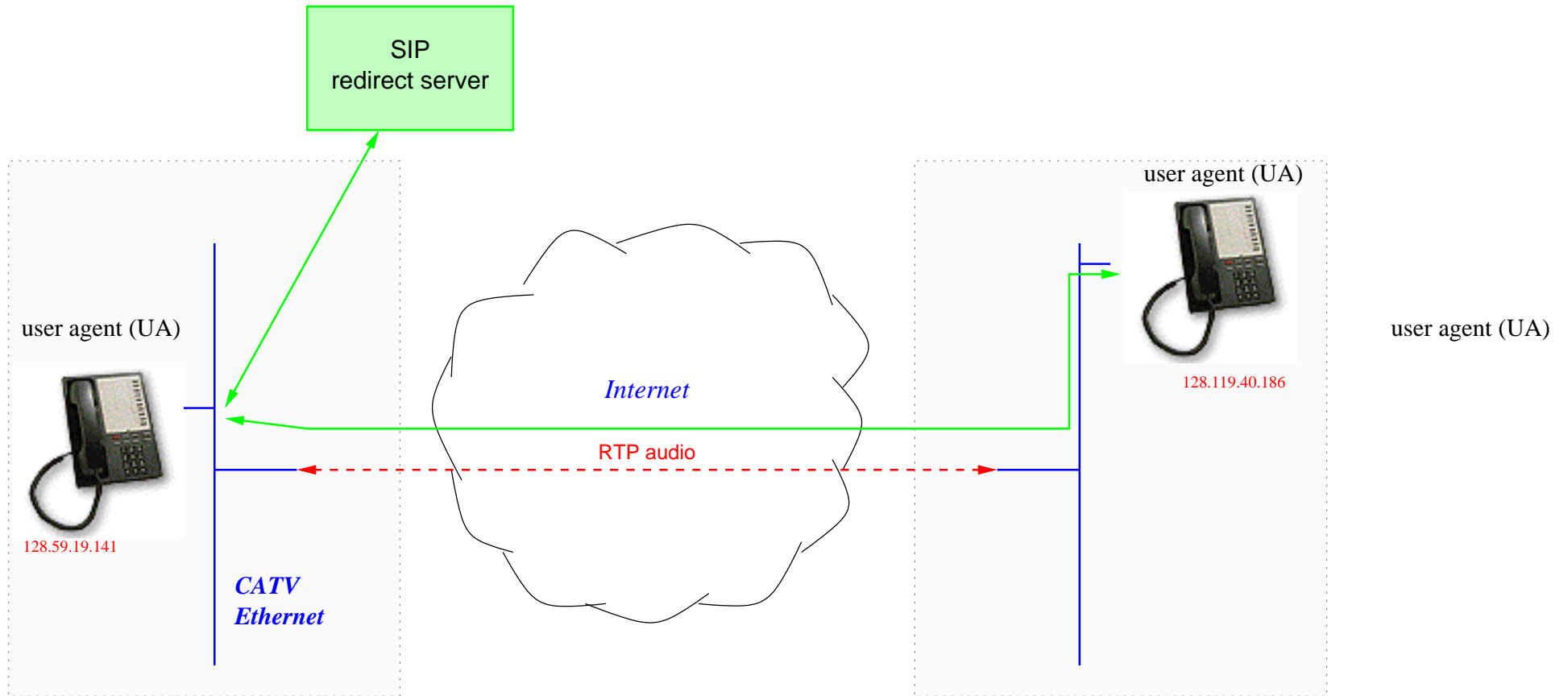

SIP architecture: outbound proxy

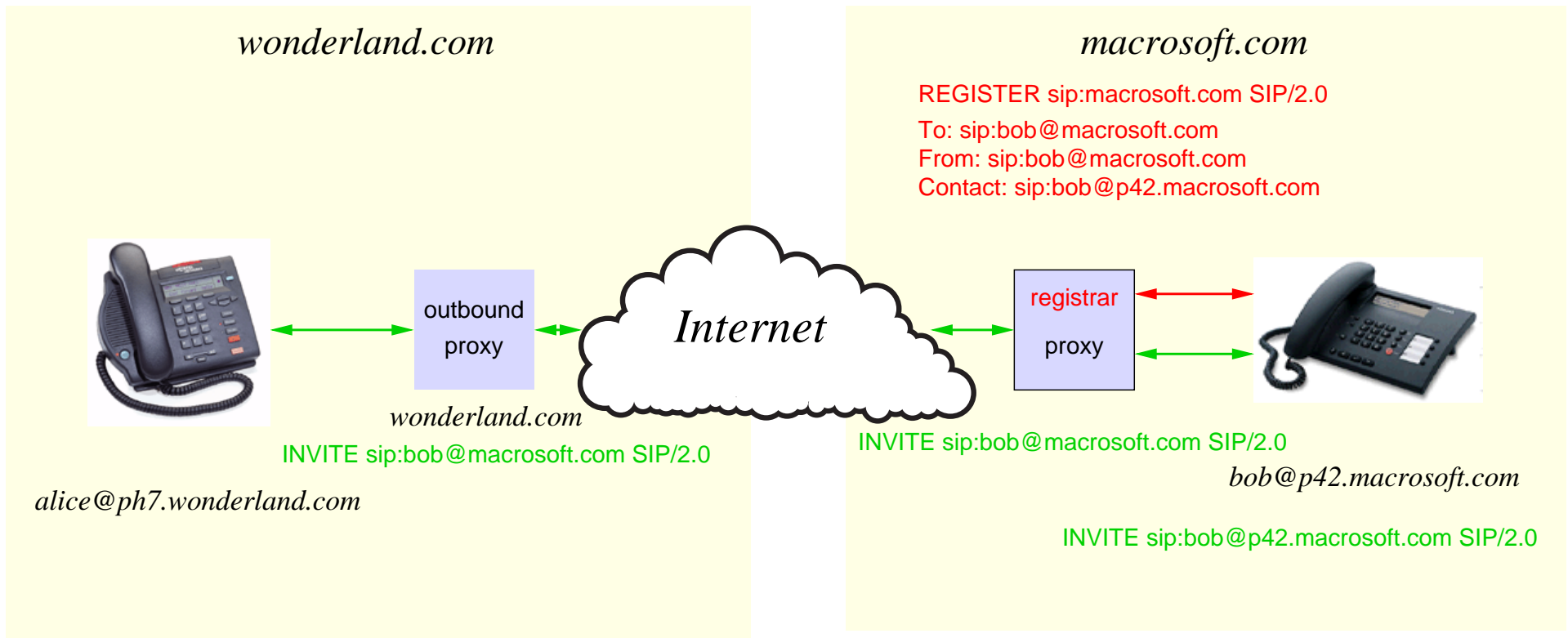

SIP architecture: VoIP to PSTN

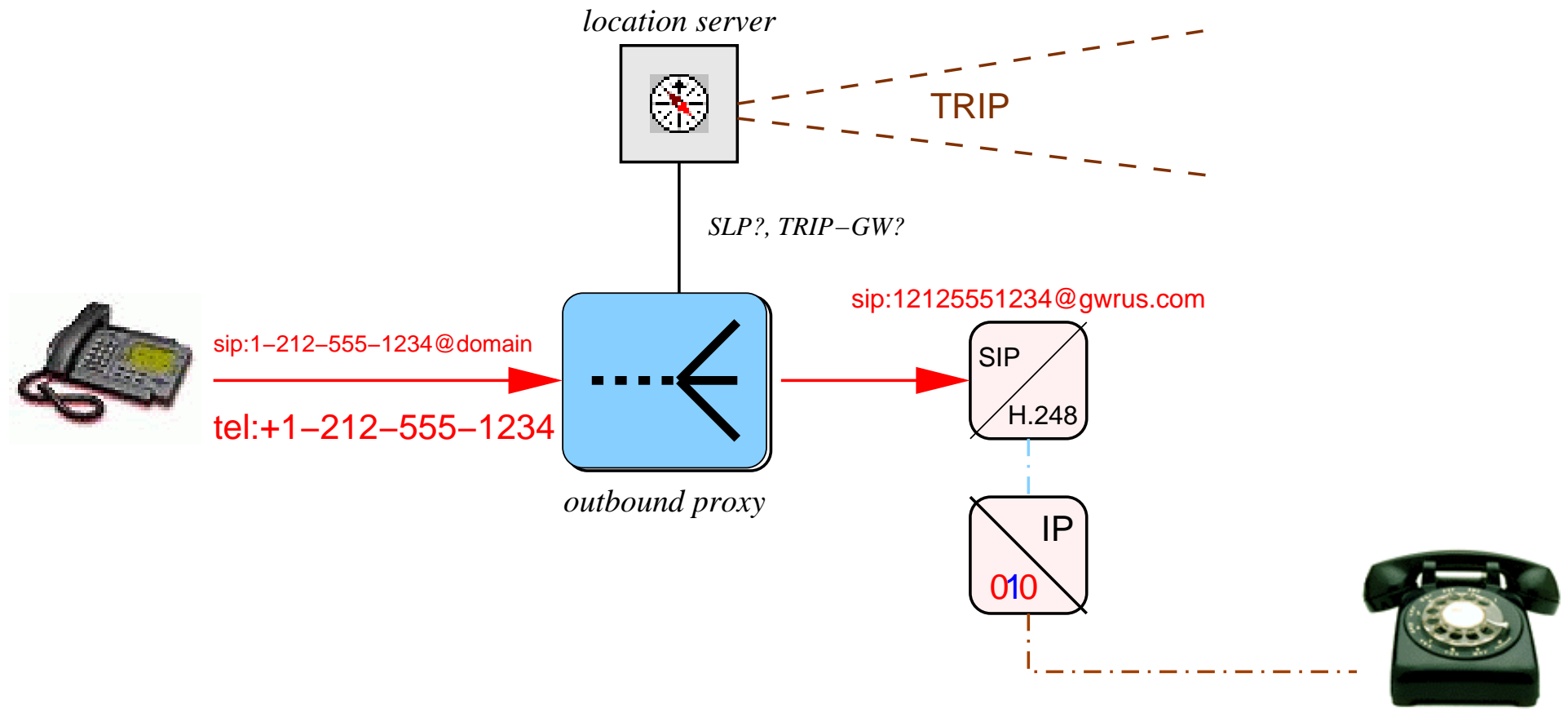

SIP architecture: PSTN to VoIP

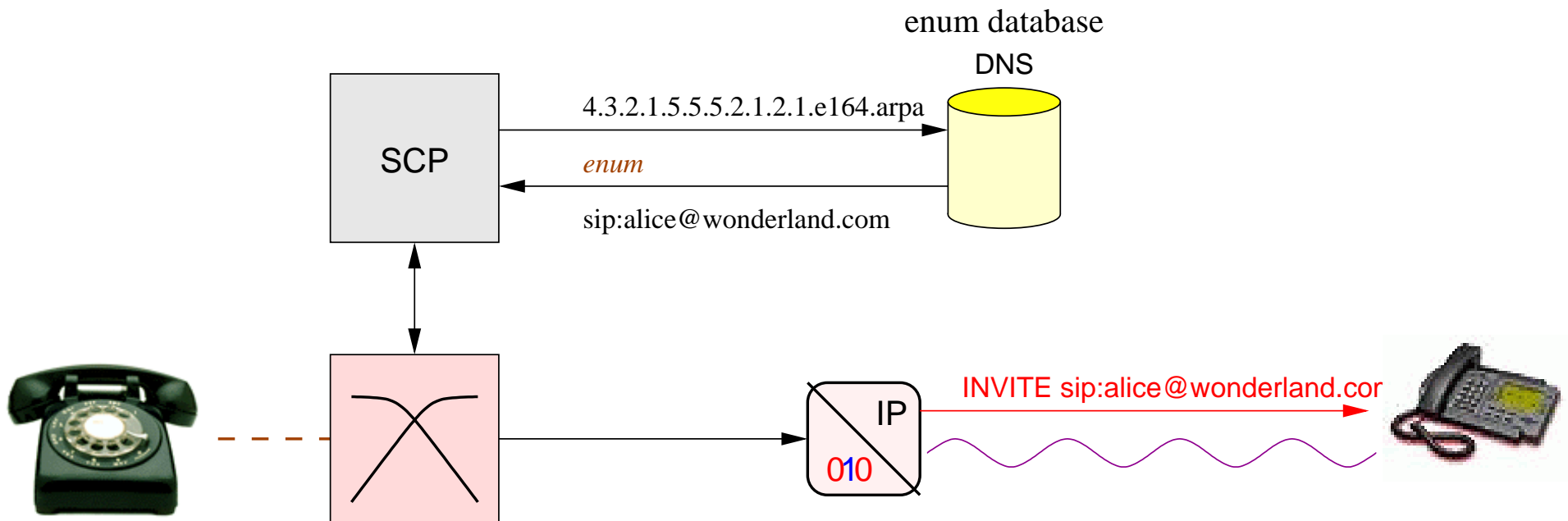

SIP operation in proxy mode

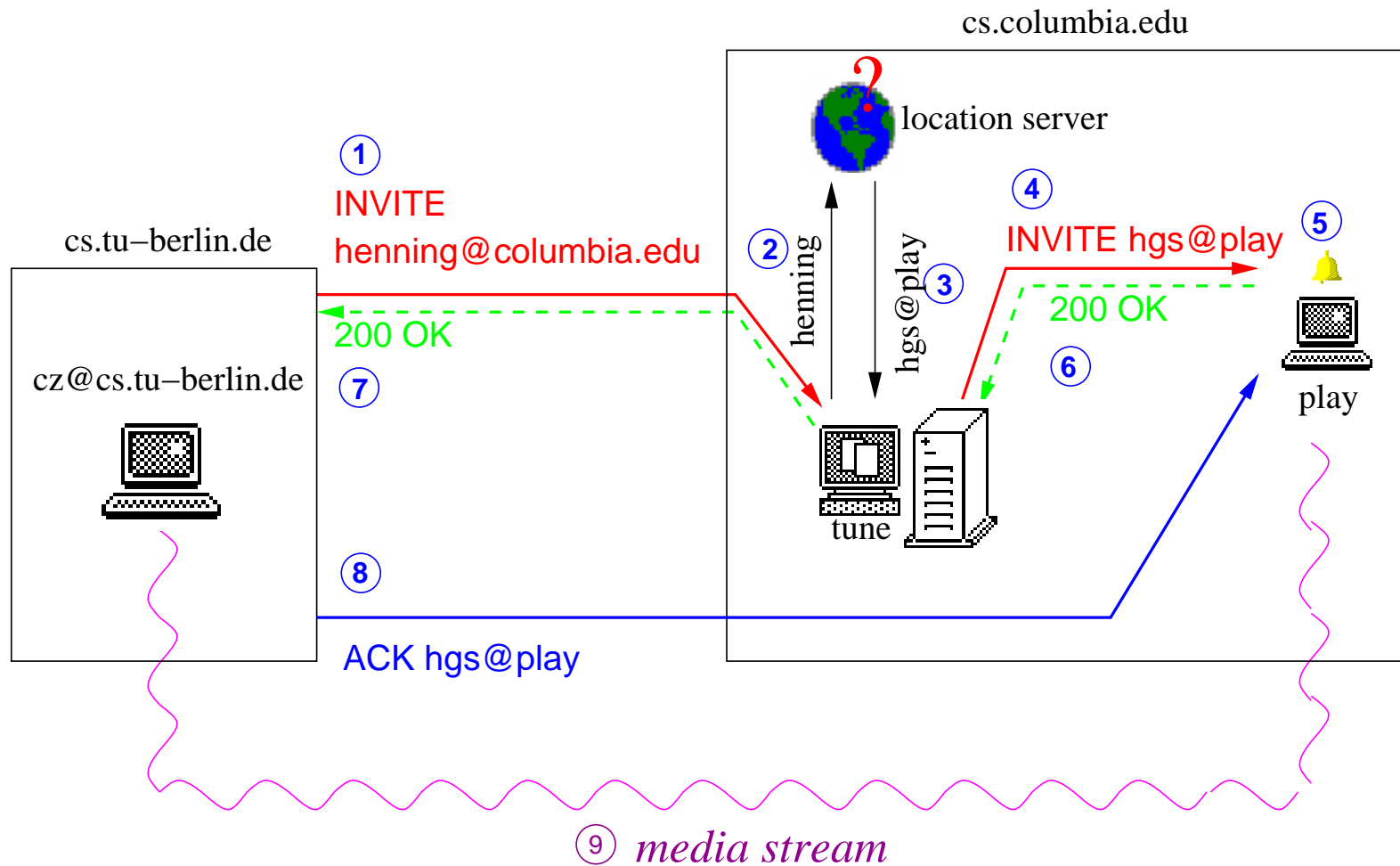

SIP operation in redirect mode

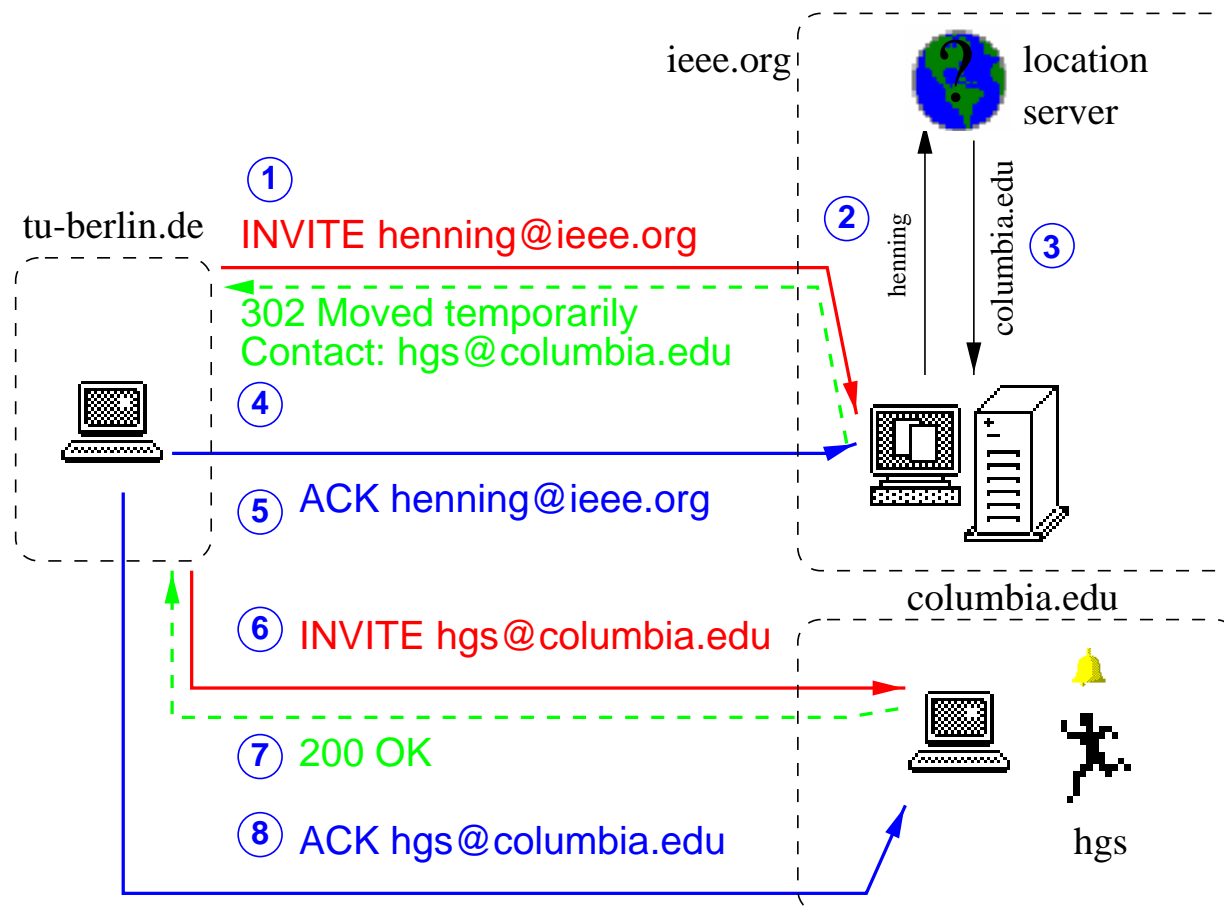

(302: redirection for single call; 301 permanently)

Locating SIP users

Locating users: registrars and location servers

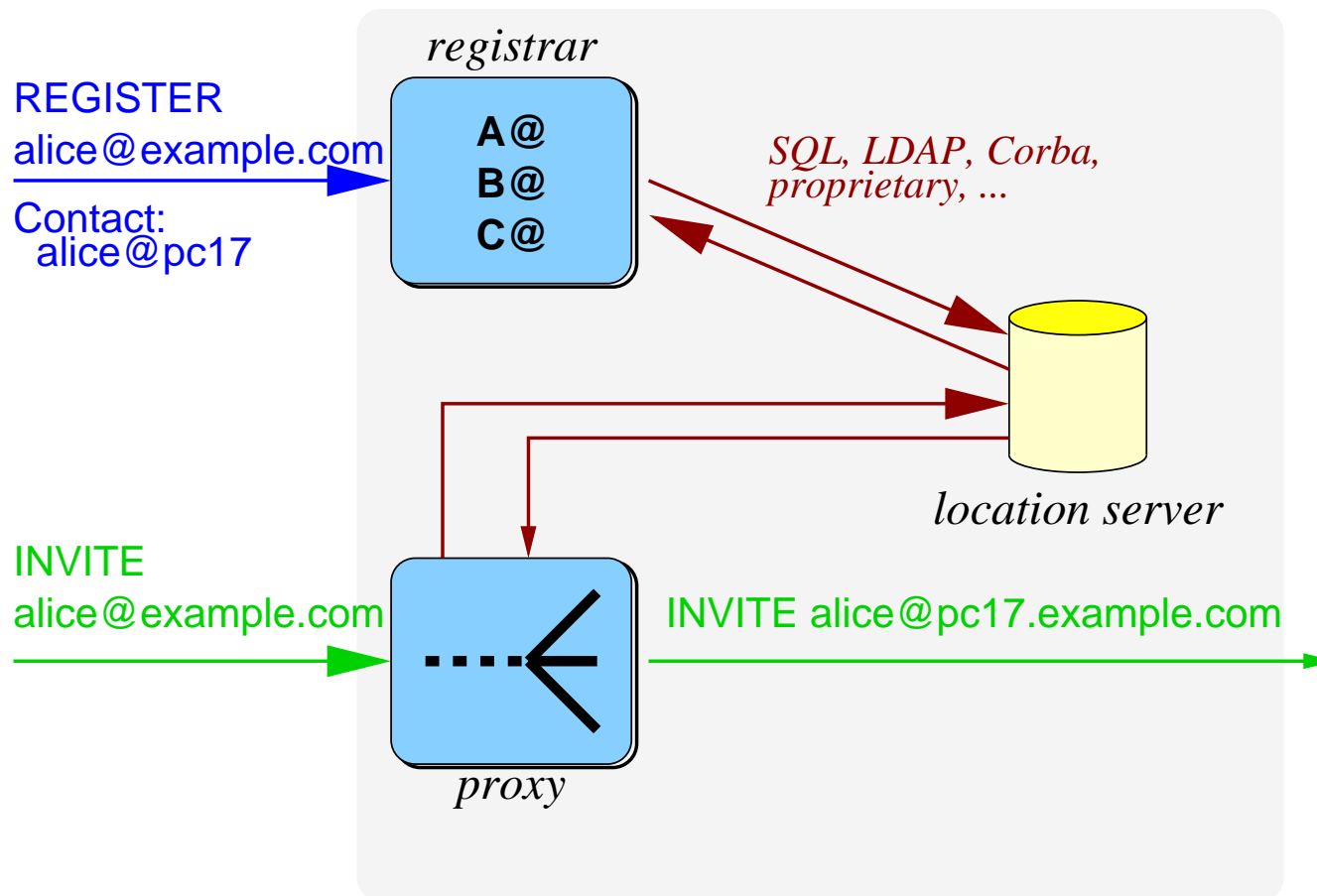

Basic user location mechanism

1. host(SIP URL) \longrightarrow host name of proxy
2. DNS: host name of proxy \rightarrow SIP server(s)
3. if SIP UAS: alert user; done
4. if SIP proxy/redirect server: map $URL_n \longrightarrow URL_{n+1}$, using any information in request
5. go to step 1

One minor exception...

Basic SIP “routing” mechanisms

- will fill in details later
- route using request URIs
- all but first request in call typically bypass proxies and go direct UAC – UAS
- however, can use “record-routing” to force certain proxies to be visited all the time
- responses always traverse the same route as requests

Outbound proxies

- normally, proxy serves one or more domains
- outbound proxies are used for *all* outbound requests from within a domain
- typically, for managing corporate firewalls and policy enforcement
- may also provide dial plans or route tel/fax URLs
- other uses: lawyer client billing, ...

Locating users: DNS SRV

- email: DNS MX record allows mapping of domain to mail host, e.g.

```
host -t mx yahoo.com
```

```
yahoo.com           MX           1  mx2.mail.yahoo.com
yahoo.com           MX           1  mx3.mail.yahoo.com
yahoo.com           MX           1  mx1.mail.yahoo.com
yahoo.com           MX           9  mta-v1.mail.yahoo.com
```

- SIP: use a newer record for general-purpose mapping, SRV (RFC 2782)
- mapping from service and transport protocol to one or more servers, including protocols

```
_sip._tcp           SRV 0 0 5060 sip-server.cs.columbia.edu.
                    SRV 1 0 5060 backup.ip-provider.net.
_sip._udp           SRV 0 0 5060 sip-server.cs.columbia.edu.
                    SRV 1 0 5060 backup.ip-provider.net.
```

- allows priority (for back-up) and weight (for load balancing)

Using DNS SRV for scalable load-balancing

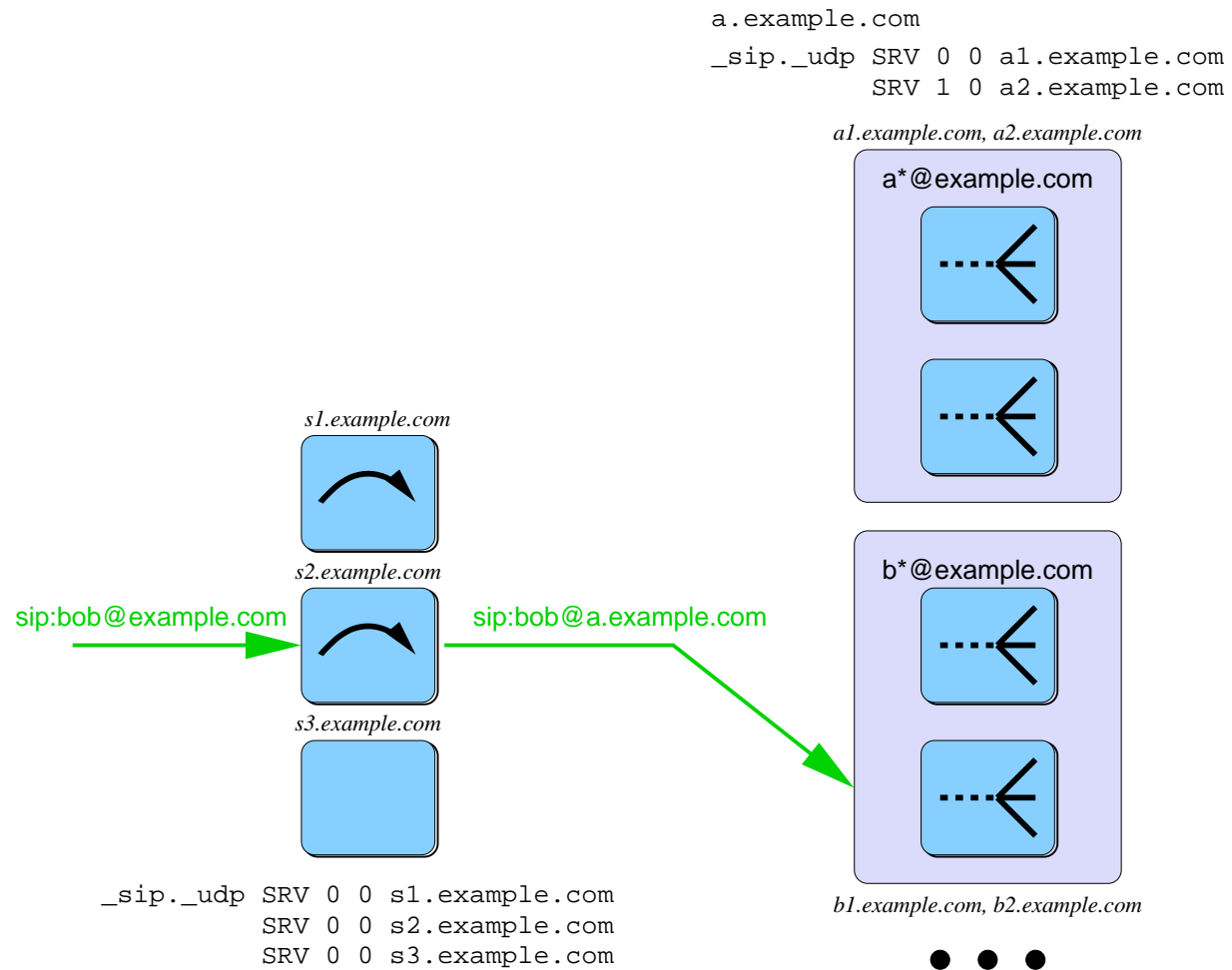

Aside: SIP scaling

- HTTP request director \leftrightarrow SIP client-based
- HTTP randomized DNS (short TTL!) \leftrightarrow SRV weights and priorities
- can't just distribute requests randomly, since backend (registration) synchronization is needed
- registration scaling: requests/second * 3600; e.g., 100 requests/second \Rightarrow 360,000 users/server
- major bottlenecks are logging and database updates
- generally, higher registration than INVITE rates

SIP protocol operation

SIP requests and responses

- text, not binary, format
- look very similar to HTTP/1.1
- requests and responses are similar except for first line
- requests and responses can contain *message bodies*: typically session descriptions, but also ASCII or HTML

SIP syntax

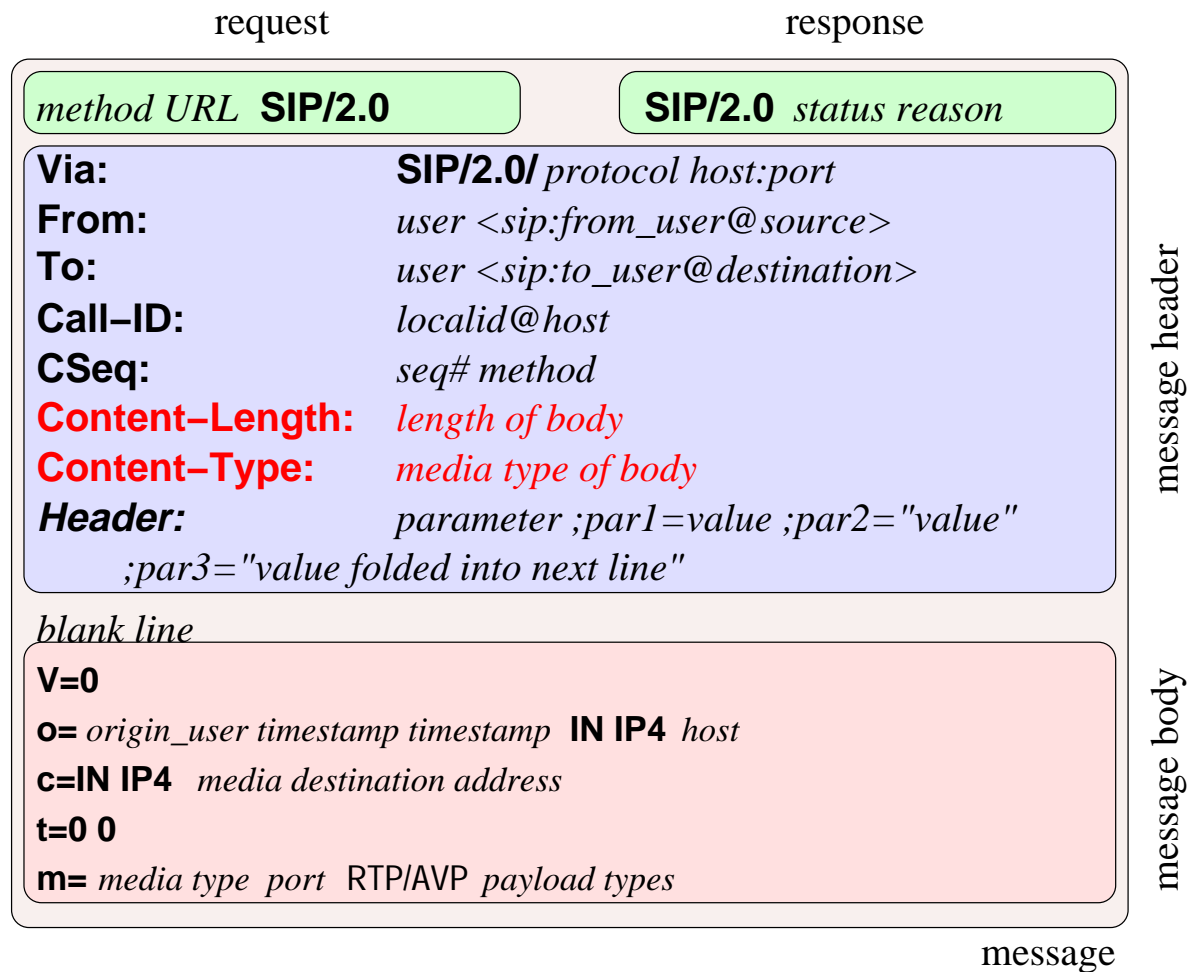

SIP syntax

- field names and some tokens (e.g., media type) are case-insensitive
- everything else is case-sensitive
- white space doesn't matter except in first line
- lines can be folded
- multi-valued header fields can be combined as a comma-list

SIP methods

INVITE	initiate call
ACK	confirm final response
BYE	terminate (and transfer) call
<hr/>	
CANCEL	cancel searches and “ringing”
OPTIONS	features support by other side
REGISTER	register with location service
<hr/>	
INFO	mid-call information (ISUP)
COMET	precondition met
PRACK	provisional acknowledgement
SUBSCRIBE	subscribe to event
NOTIFY	notify subscribers
REFER	ask recipient to issue SIP request (call transfer)

SIP invitation and media negotiation

alice@wonderland.com

calls

bob@macrosoft.com

INVITE sip:bob@macrosoft.com SIP/2.0

From: sip:alice@wonderland.com

To: sip:bob@macrosoft.com

Call-ID: 31415@wonderland.com

CSeq: 42 INVITE

Content-Type: application/sdp

v=0

o=user1 536 2337 IN IP4 h3.wonderland.com

c=IN IP4 h3.wonderland.com

m=audio 3456 RTP/AVP 0 1

m=video 4000 RTP/AVP 38 39

SIP/2.0 200 OK

From: sip:alice@wonderland.com

To: sip:bob@macrosoft.com

Call-ID: 31415@wonderland.com

CSeq: 42 INVITE

Content-Type: application/sdp

v=0

o=user1 535 687637 IN IP4 m.macrosoft.com

c=IN IP4 m.macrosoft.com

m=audio 1200 RTP/AVP 1

m=video 0 RTP/AVP

accept audio, decline video

Tagging To

- after forking and merging, hard to tell who responded
- UAS responds with random **tag** added to disambiguate

```
To: "A. G. Bell" <sip:agb@bell-telephone.com>  
    ;tag=a48s
```

- future requests are ignored if they contain the wrong tag

SIP call legs

- *call leg*: From, To, Call-ID
- requests from callee to caller reverse To and From
- caller and callee keep their own CSeq space
- either side can send more INVITEs or BYE

SIP responses

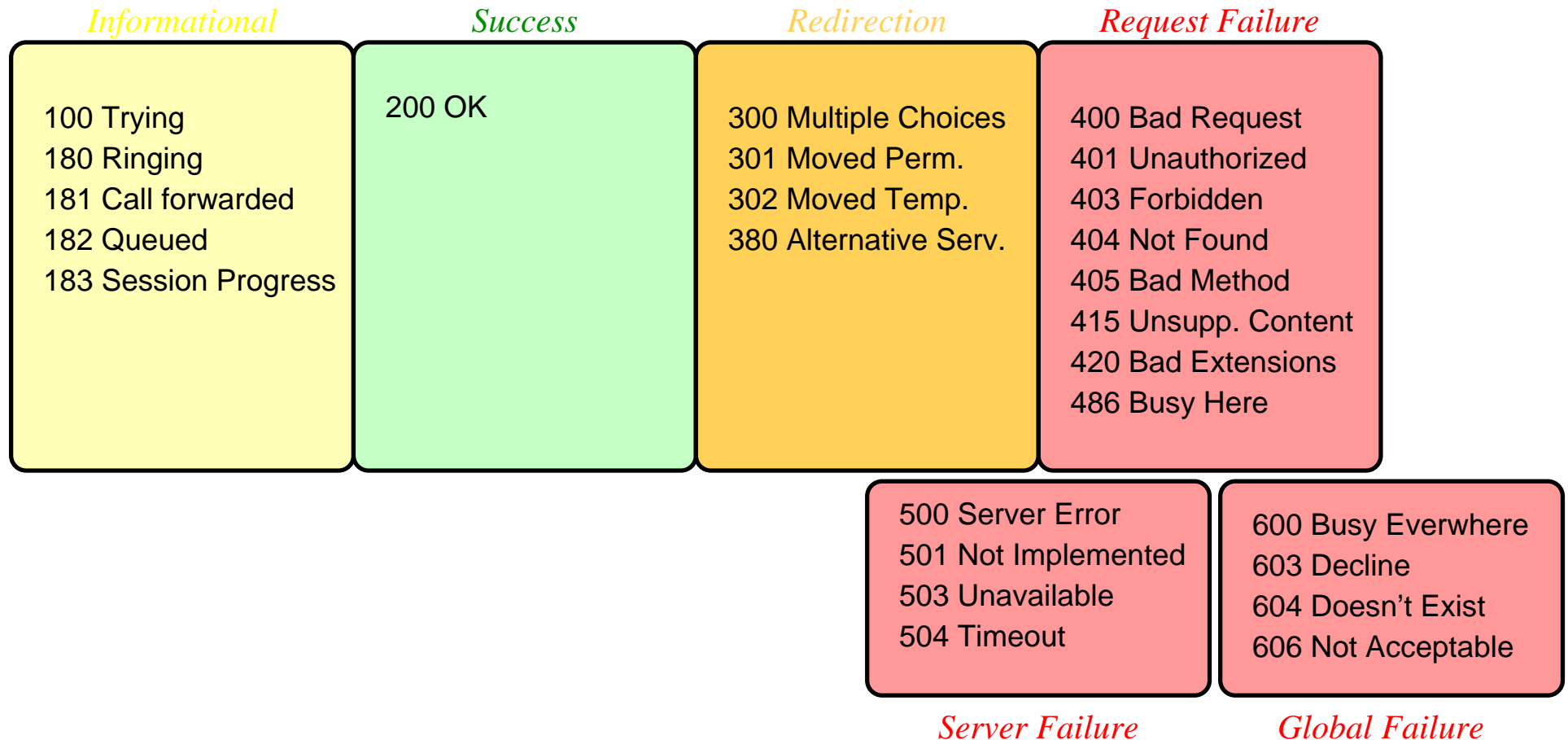

SIP response routing

- requests are routed via URL
- response traces back request route *without proxy server state*
- forward to host, port in next Via
- TCP: re-use connection if possible, create new one if needed
- UDP: may send responses to same port as requests

```
Via: SIP/2.0/UDP server.domain.org:5060  
;received=128.1.2.3
```

SIP response routing

alice@example.com

bob_doe@yahoo.com

bob@columbia.edu

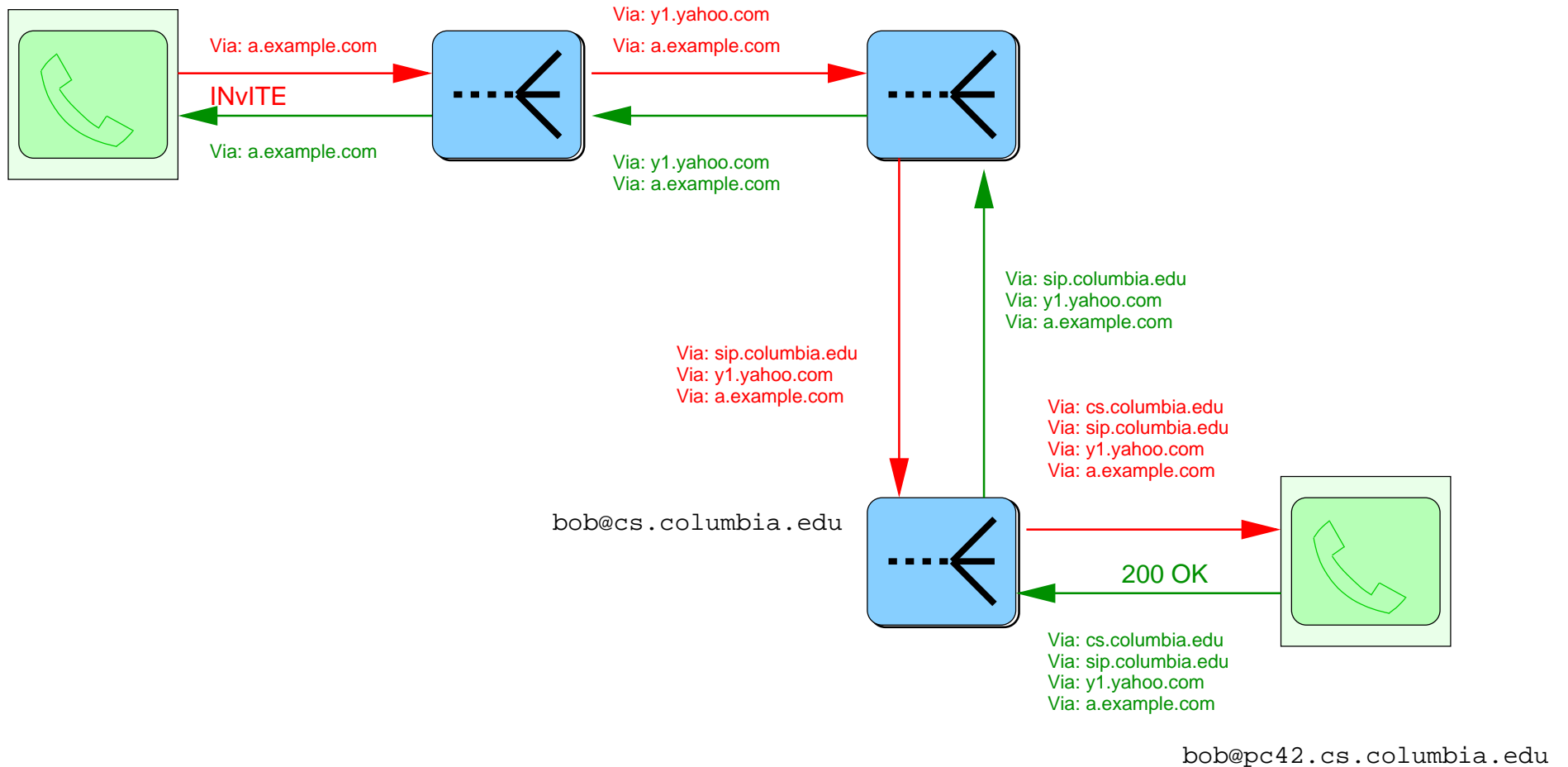

SIP spirals

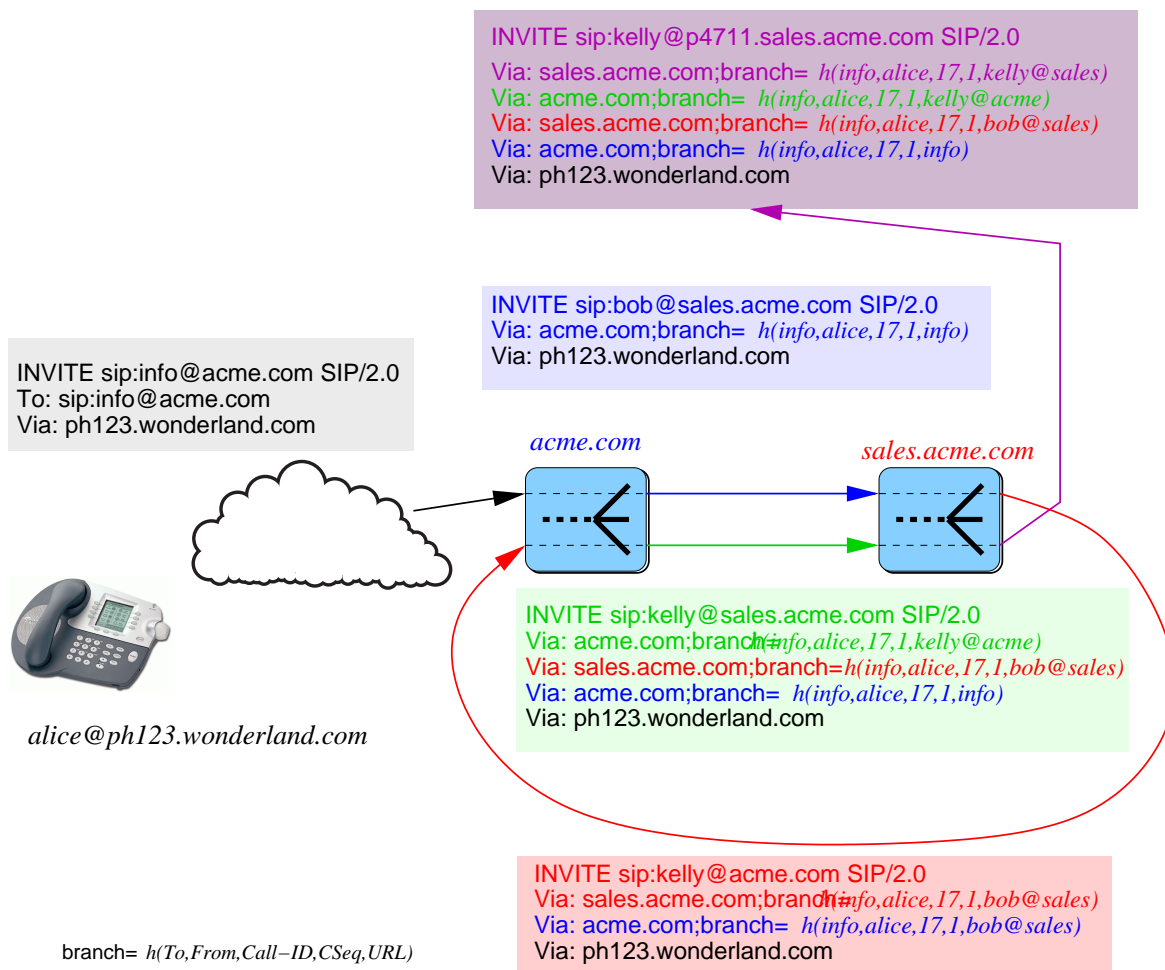

Forcing request paths

- usually, bypass proxies on subsequent requests
- some proxies want to stay in the path → call-stateful:
 - firewalls
 - anonymizer proxies
 - proxies controlling PSTN gateways
- use Record-Route and Route

Request routing

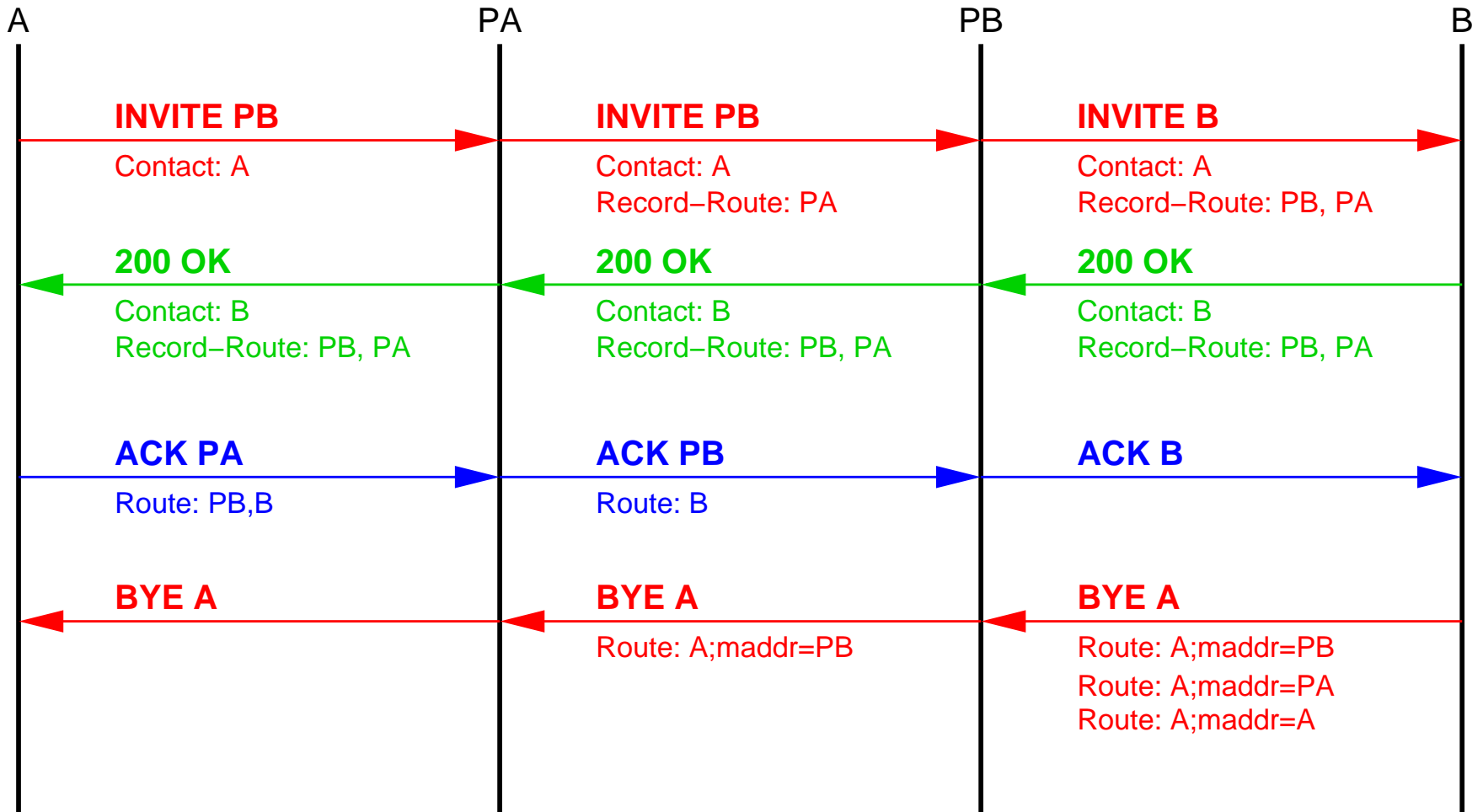

SIP request forking

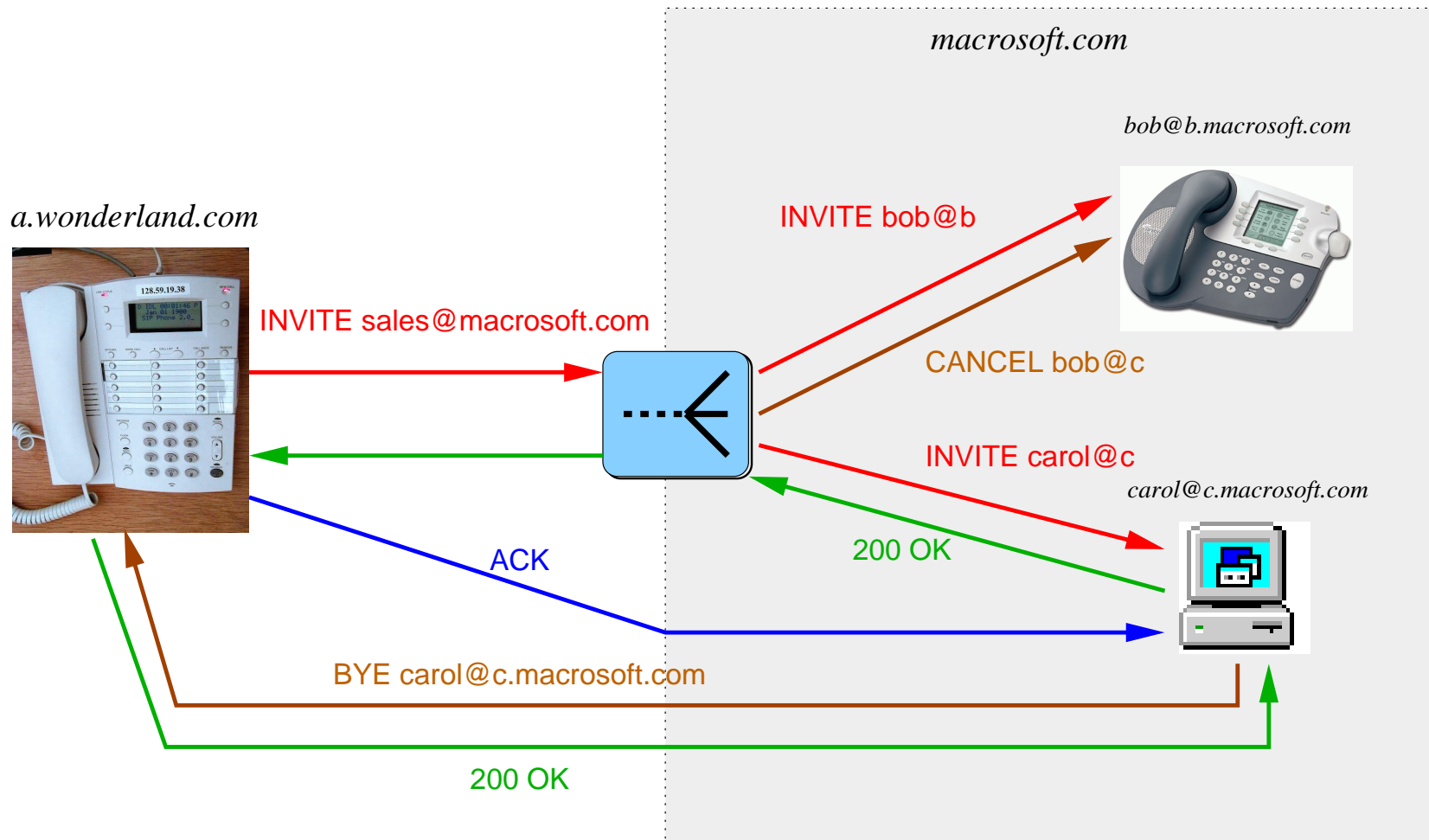

SIP sequential request forking

Use q values to govern order of sequential search:

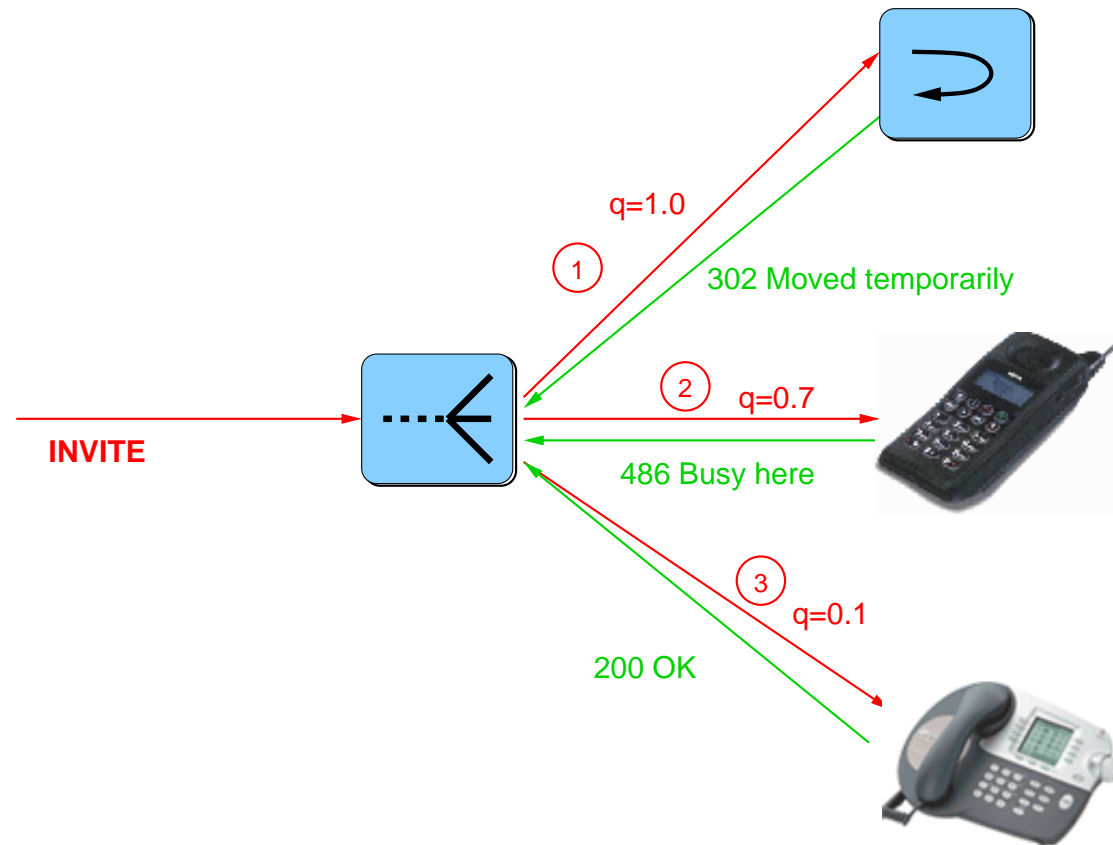

SIP request forking

- branches tried in sequence or parallel (or some combination)
- recursion: may try new branches if branch returns 3xx
- return best final answer = lowest status code
- forward provisional responses

Parallel forking call flow

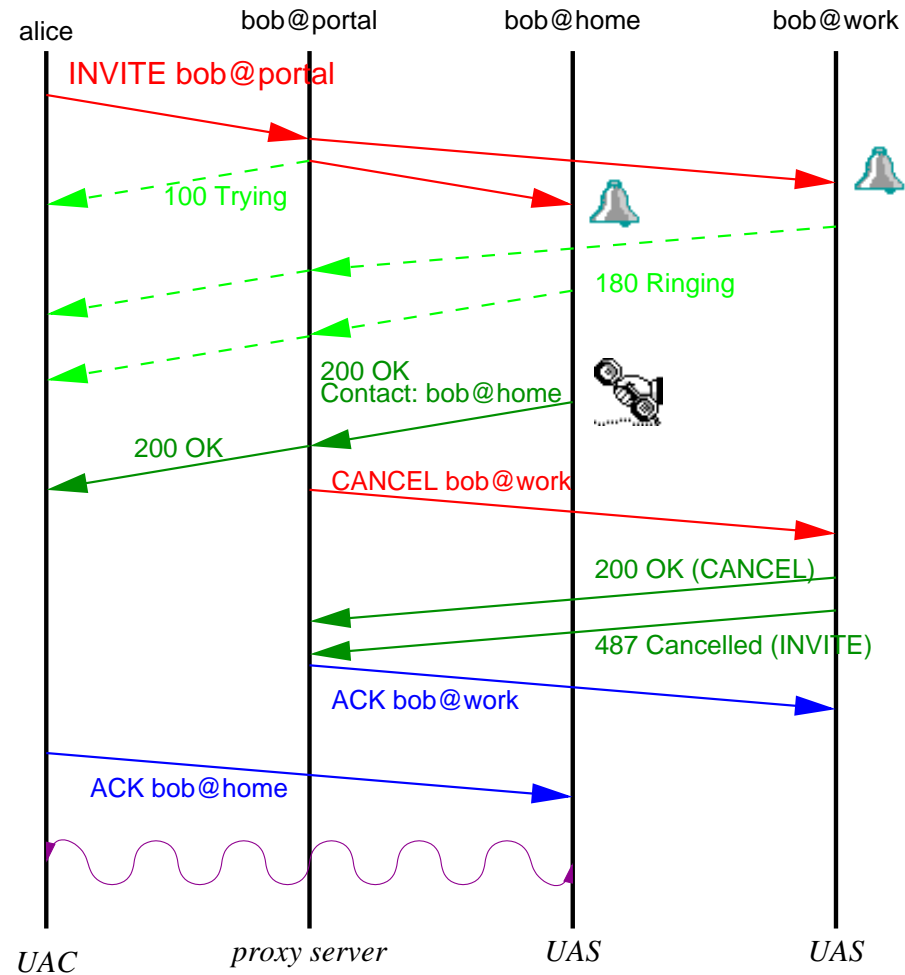

SIP transport issues

- SIP operates over any packet network, reliable or unreliable
- choices:
 - UDP:** most common
 - low state overhead
 - small max. packet size
 - TCP:** can combine multiple signaling flows over one link
 - use with SSL
 - connection setup overhead
 - HOL blocking for trunks
 - SCTP:** new protocol
 - no HOL blocking
 - fallback address (but SRV provides this already)
 - connection setup overhead

Transport reliability for all but INVITE

- used for BYE, OPTIONS, SUBSCRIBE, NOTIFY, ...
- 1xx sent by UAS or proxy only if no final answer expected within 200 ms
- if provisional response, retransmit with $T2$ (4) seconds

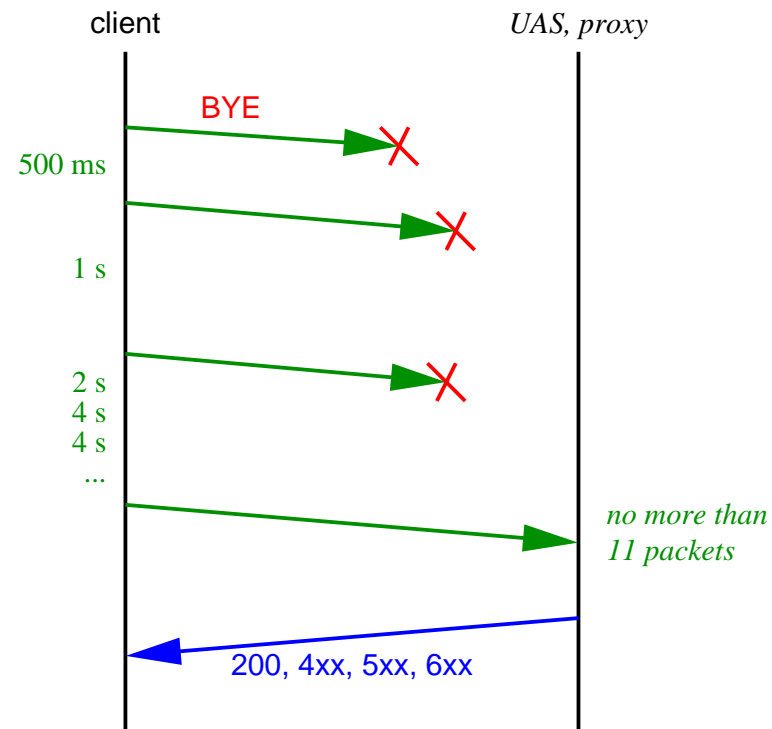

INVITE reliability

- INVITE is special – long time between request and final response
- 100 (by proxy) indicates request has been received
- proxy usually forwards 1xx from all branches
- only retransmit until 100
- ACK confirms receipt of final response

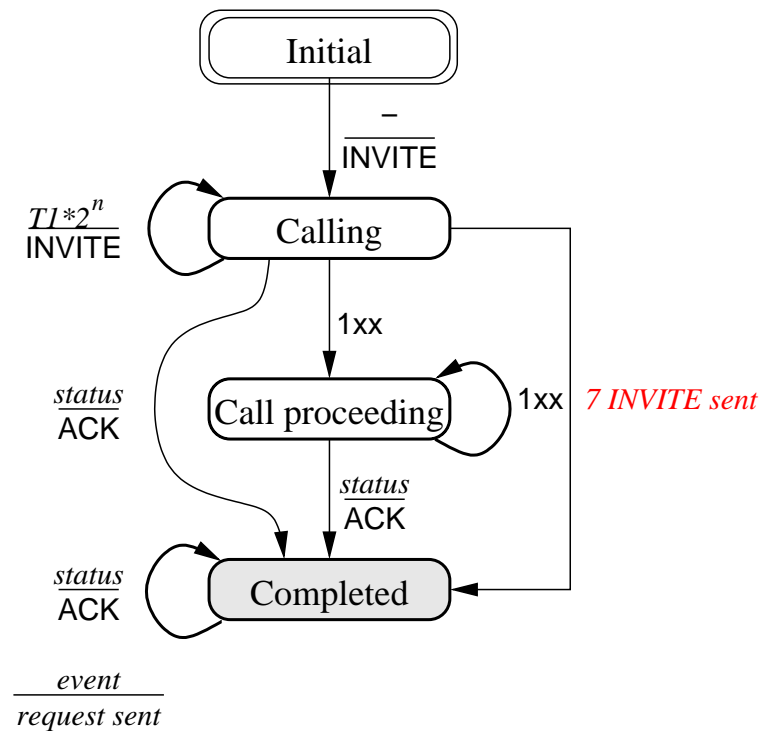

Other signaling approaches

Differences to classical signaling

name	examples	network	“channel”
in-band	E&M, DTMF	same	same
out-of-band	ISUP, Q.931	different	different
IP	SIP	typically same	different

IP signaling meets media only at end systems, while PSTN out-of-band intersects at every switch

Aside: Alternative architecture: master-slave

- master-slave: MGC (media gateway controller) controls one or more gateways
- allows splitting of signaling and media functionality
- “please send audio from circuit 42 to 10.1.2.3”
- uses MGCP (implemented) or Megaco/H.248 (standardized, but just beginning to be implemented)
- gateway can be residential
- basis of PacketCable NCS (network control system) architecture
- service creation similar to digital PBX or switch
- end system has no semantic knowledge of what’s happening
- —→ can charge for caller id, call waiting

MGCP/SIP architecture

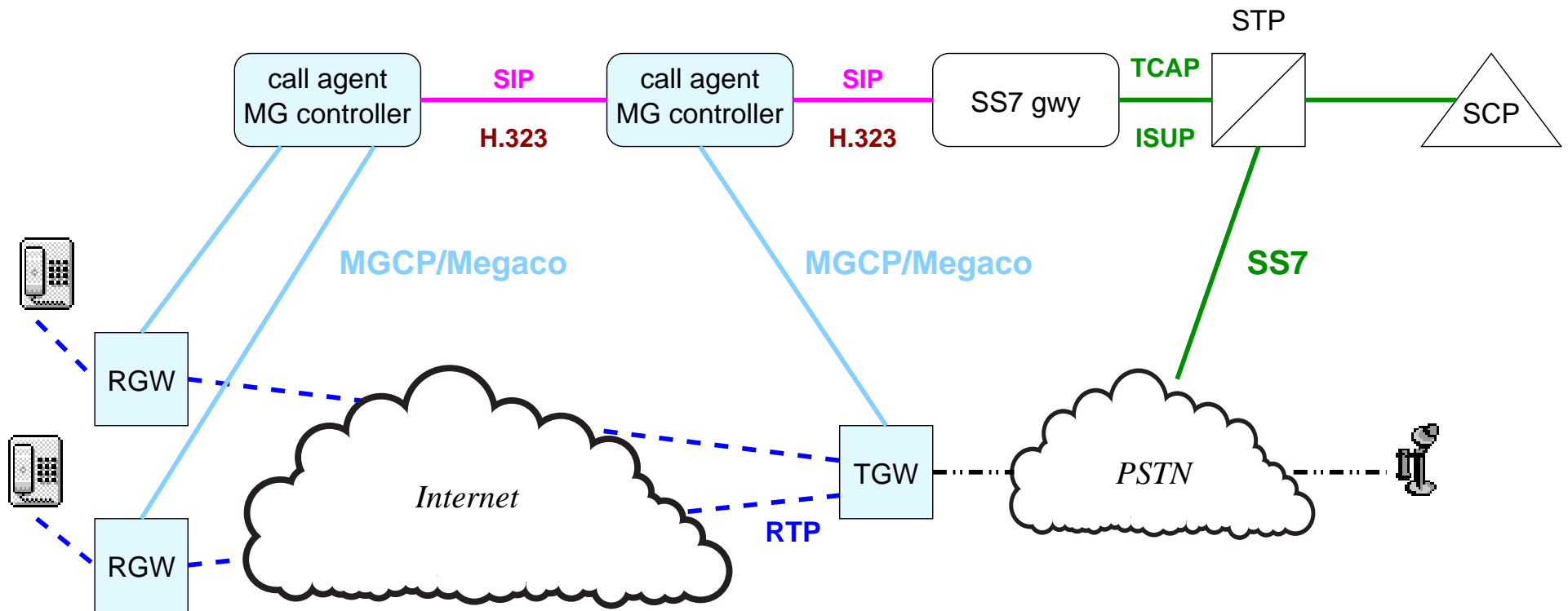

Extending SIP

extension	behavior	determine?
new headers	ignored	–
new headers	mandatory	Supported
new method		OPTIONS
new body type		Accept
new status code	class-based	
new URL type		?

SIP extensions and feature negotiation

- if crucial, mark with “Require: *feature*”
- IANA-registered features are simple names, private features use reverse domain names
- indicate features supported in Supported:

```
C->S:  INVITE sip:watson@bell-telephone.com SIP/2.0
      Require: com.example.billing
      Supported: 100rel
      Payment: sheep_skins, conch_shells
```

```
S->C:  SIP/2.0 420 Bad Extension
      Unsupported: com.example.billing
```

```
S->C:  SIP/2.0 421 Extension Required
      Require: 183
```

User identification

Standard call/caller identification

Request-URI: next hop

To: logical call destination

From: logical call origin

Organization: organization of caller/callee

Subject: subject of call

Call-Info: additional information about caller or callee

Call-Info:

```
<http://www.example.com/alice/photo.jpg> ;purpose=icon,  
<http://www.example.com/alice/> ;purpose=info
```

User-Agent: make and model of user agent

Additional call information

Priority: call priority: emergency, urgent, normal, non-urgent

Alert-Info: render instead of ring tone

Alert-Info: <http://www.example.com/sounds/moo.wav>

In-Reply-To: call-id being returned

draft-ietf-sip-privacy

- To/headerFrom are chosen by end system → may lie
- need privacy indications similar to caller id

```
Remote-Party-ID: "John Doe"  
                  <sip:jdoe@foo.com>;party=calling;  
                  id-type=subscriber;privacy=full
```

- screen=yes: was verified by proxy
- type can be subscriber, user, alias, return (calls), term (terminal)
- may add geographic user location

SIP services

Invitation modes

signaling		media
	unicast	multicast
unicast	telephony	multicast session
multicast	reach first	dept. conference

⇒ SIP for all modes, SAP/SDP also for multicast/multicast

SIP-based services

Call forwarding: basic INVITE behavior (proxy/redirect)

Call transfer: REFER method (see later)

Call hold: set media address to 0.0.0.0 – can be done individually per media

Caller id: From, plus extensions

DTMF carriage: carry as RTP payload (RFC 2833)

Calling card: B2BUA + voice server

Voice mail: UA with special URL(s) + possibly RTSP

Call transfer

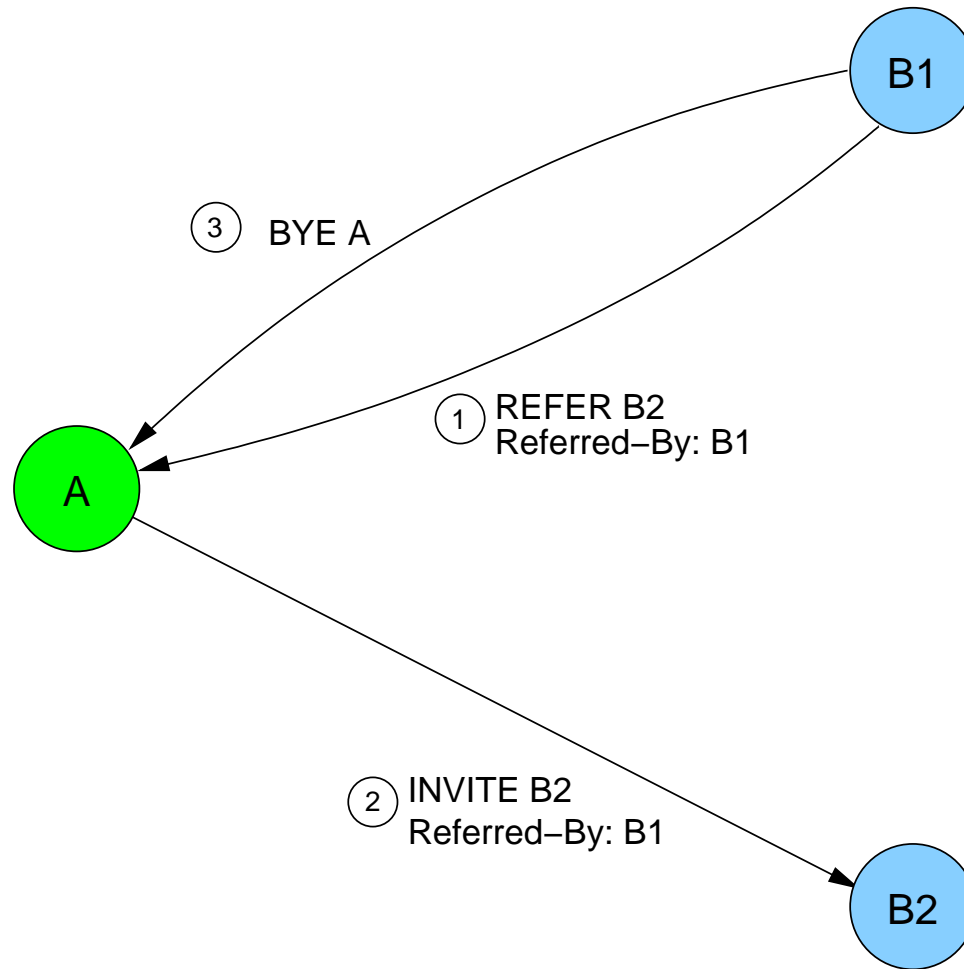

IVR and VoiceXML

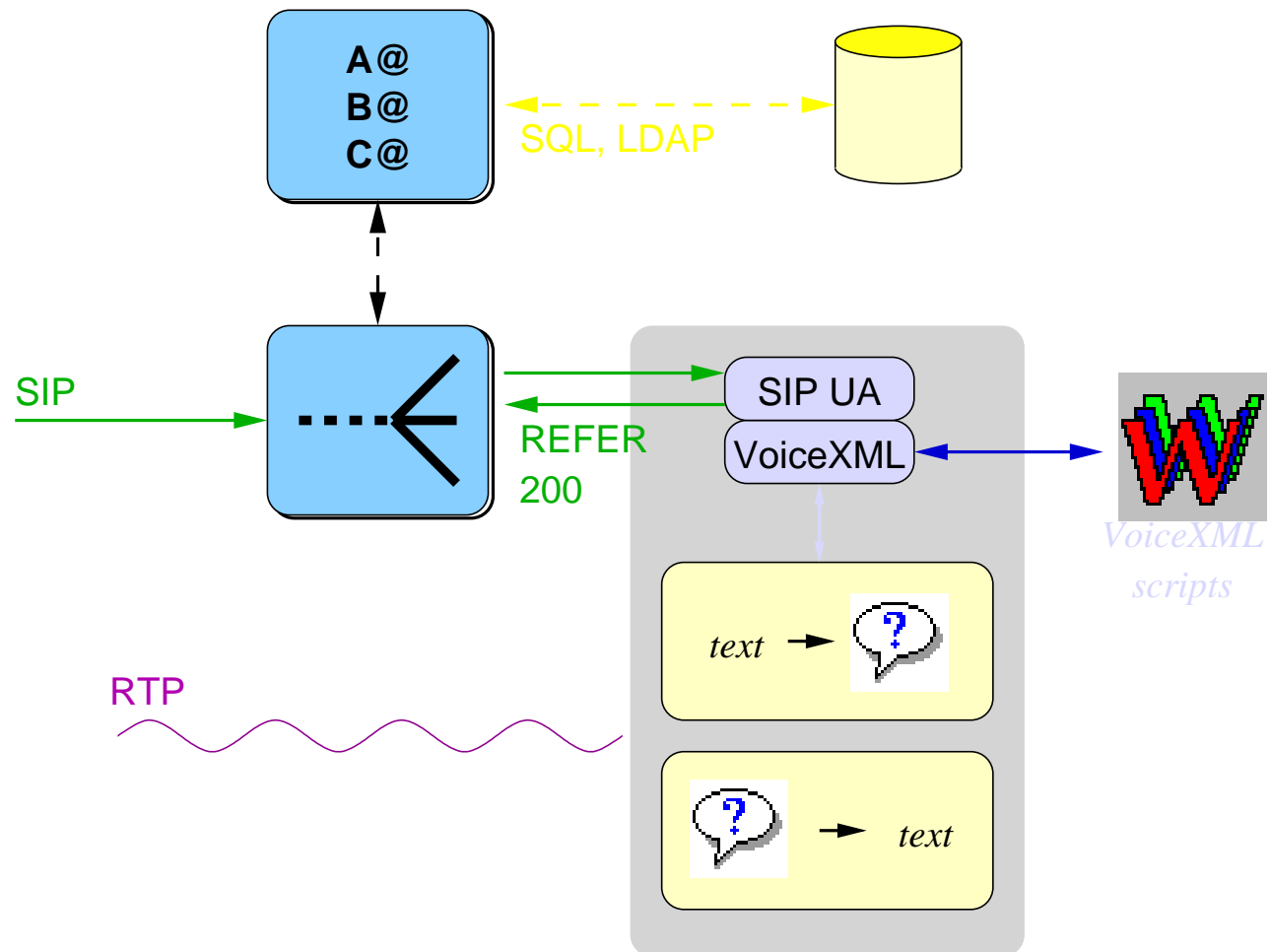

Third-party call control

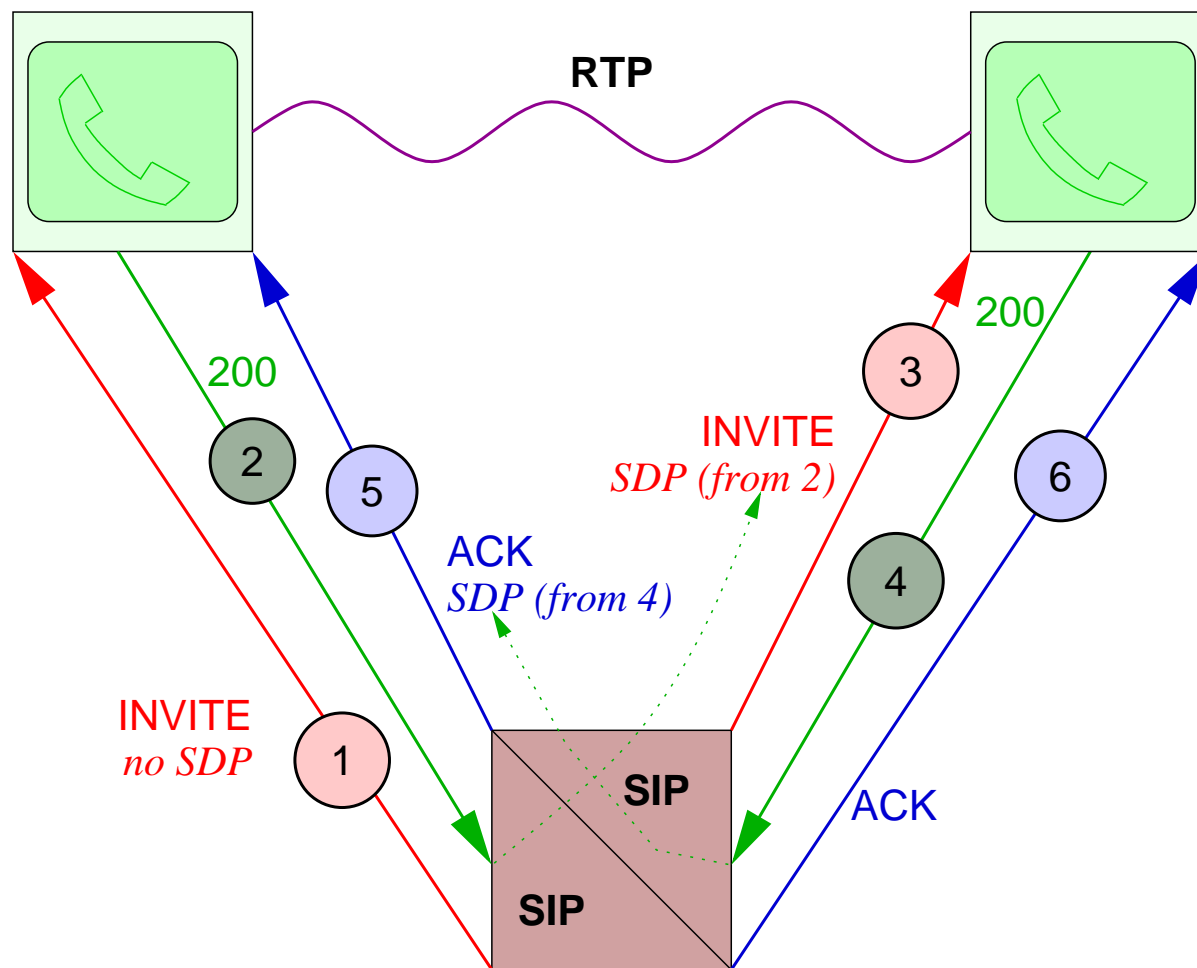

SIP billing/charging

What for?

- transport \rightsquigarrow resource reservation protocol
- SIP services (call processing) \rightsquigarrow authentication
- PSTN gateway services
- media server services (translation, storage)

How?

- resource reservation protocols
- SIP-in-DIAMETER approach
- server log files

Security issues

Threats

- spoofing From in REGISTER: call redirection
- spoofing From in INVITE: bypass call filtering
- snooping media packets
- billing confusion (identifier munging)
- denial-of-service attacks

SIP security

layer/mechanism	approach	characteristics
network layer	IPsec	adjacent nodes, all or nothing, hard to configure
transport layer	TLS	adjacent nodes, all or nothing
SIP INVITE	basic/digest	shared secrets with random parties
SIP REGISTER	basic/digest	securing headers?
SIP general	S/MIME	in progress

Basic (plaintext password) and digest (challenge-response) are very similar to HTTP security mechanisms.

SIP authentication

Basic: include plain-text password in request, immediately or after 401 (Unauthorized) or 407 (Proxy Authorization) response

Digest: challenge-response with shared secret

Certificate: sign non-Via parts of request headers, body with PGP, PKCS #7

SSL, SSH: but only for TCP

- but: need more elaborate cryptographic capability indication in SDP

Basic authentication

- Challenge by UAS:

```
SIP/2.0 401 Unauthorized
WWW-Authenticate: Basic realm="business"
```

- client responds with

```
INVITE sip:alice@wonderland.com SIP/2.0
CSeq: 2 INVITE
Authorization: QWxhZGRpbjpvvcGVuIHNLc2FtZQ==
where authorization is base64(userid:password)
```

- usually caller → callee, but challenge can be in request

Digest authentication

- *A* calls *B* and fails:

```
SIP/2.0 401 Unauthorized
Authenticate: Digest realm="GW service",
    domain="wcom.com",
    nonce="wf84f1ceczx41ae6cbe5aea9c8e88d359",
    opaque="42", stale="FALSE", algorithm="MD5"
```

- *A* tries again:

```
INVITE sip:UserB@ss1.wcom.com SIP/2.0
Authorization:Digest username="UserA",
    realm="GW service",
    nonce="wf84f1ceczx41ae6cbe5aea9c8e88d359",
    opaque="42", uri="sip:UserB@ss1.wcom.com",
    response="42ce3cef44b22f50c6a6071bc8"
```

Digest authentication

username: user authenticating herself

realm: several per user, used also for display

nonce: copied into Authorization

opaque: copied into Authorization

uri: original request URL

response: 32 hex digits:

KD (H(A_1), nonce-value : H(A_2))

for MD5: H(H(A_1) : nonce-value : H(A_2)))

where $A_1 = \textit{username} : \textit{realm} : \textit{passwd}$

$A_2 = \textit{method} : \textit{uri}$

Quality of Service

Quality of service

- SIP and data paths disjoint \Rightarrow SIP can't reserve resources
- but: SDP may provide information to end systems on desired QoS
- SDP contains range of codecs to allow mid-call adaptation

Interaction with resource reservation

avoid “fast busy” after ringing \Rightarrow interleave

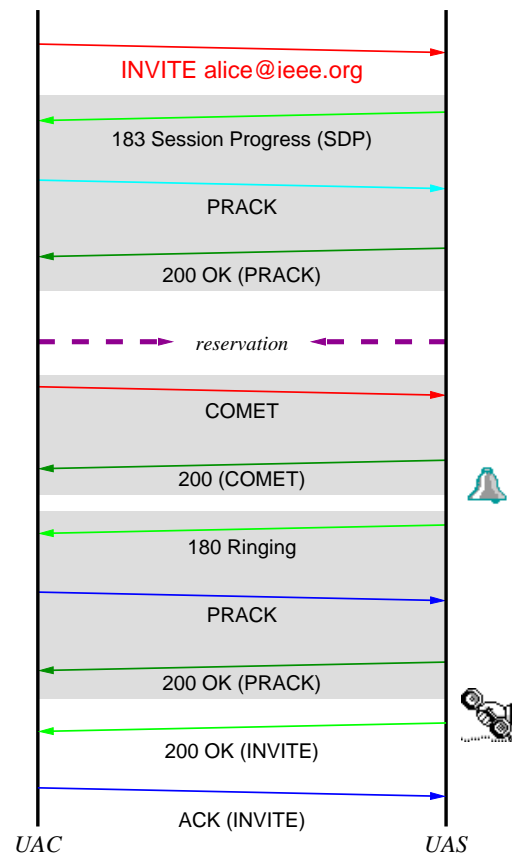

SIP Caller Preferences

Preferences

callee: scripts, CPL, REGISTER advice in Contact, ...

caller: help guide routing (“no home number”) and order of attempts when forking
 (“try videophone first, then phone, then answering service”)

“caller proposes, callee disposes”

Extended SIP Contact header

q	location preference
class	business, residence
description	show to caller
duplex	full or half-duplex
feature	call handling features
language	languages spoken
media	audio, video, text/numeric, ...
mobility	fixed or mobile
priority	“only in case of emergency”
scheme	URL schemes (tel, http, ...)
service	IP, PSTN, ISDN, pager, ...

Contact example

q=quality gives preference.

```
SIP/2.0 302 Moved temporarily
```

```
Contact: sip:hgs@erlang.cs.columbia.edu  
  ;action=redirect ;service=IP,voice-mail  
  ;media=audio ;duplex=full ;q=0.7;
```

```
Contact: tel:+1-415-555-1212 ; service=ISDN  
  ;mobility=fixed ;language=en,es,iw ;q=0.5
```

```
Contact: tel:+1-800-555-1212 ; service=pager  
  ;mobility=mobile  
  ;duplex=send-only;media=text; q=0.1; priority=urgent;  
  ;description="For emergencies only"
```

```
Contact: mailto:hgs@cs.columbia.edu
```

Accept-Contact and Reject-Contact

- determine order of contacting users:

```
Accept-Contact: sip:sales@acme.com ;q=0,  
;media="!video" ;q=0.1,  
;mobility="fixed" ;q=0.6,  
;mobility="!fixed" ;q=0.4
```

☞ “avoid connecting me to sales; I prefer a landline phone; try

- Reject-Contact: rule out destinations

```
Reject-Contact: ;class=personal
```

Request-Disposition

- proxy or redirect
- cancel ringing second phone after first picked up?
- allow forking?
- search recursively?
- search sequentially or in parallel?
- queue the call?

Request-Disposition: proxy, recurse, parallel

SIP presence, events and instant messaging

SIP presence architecture

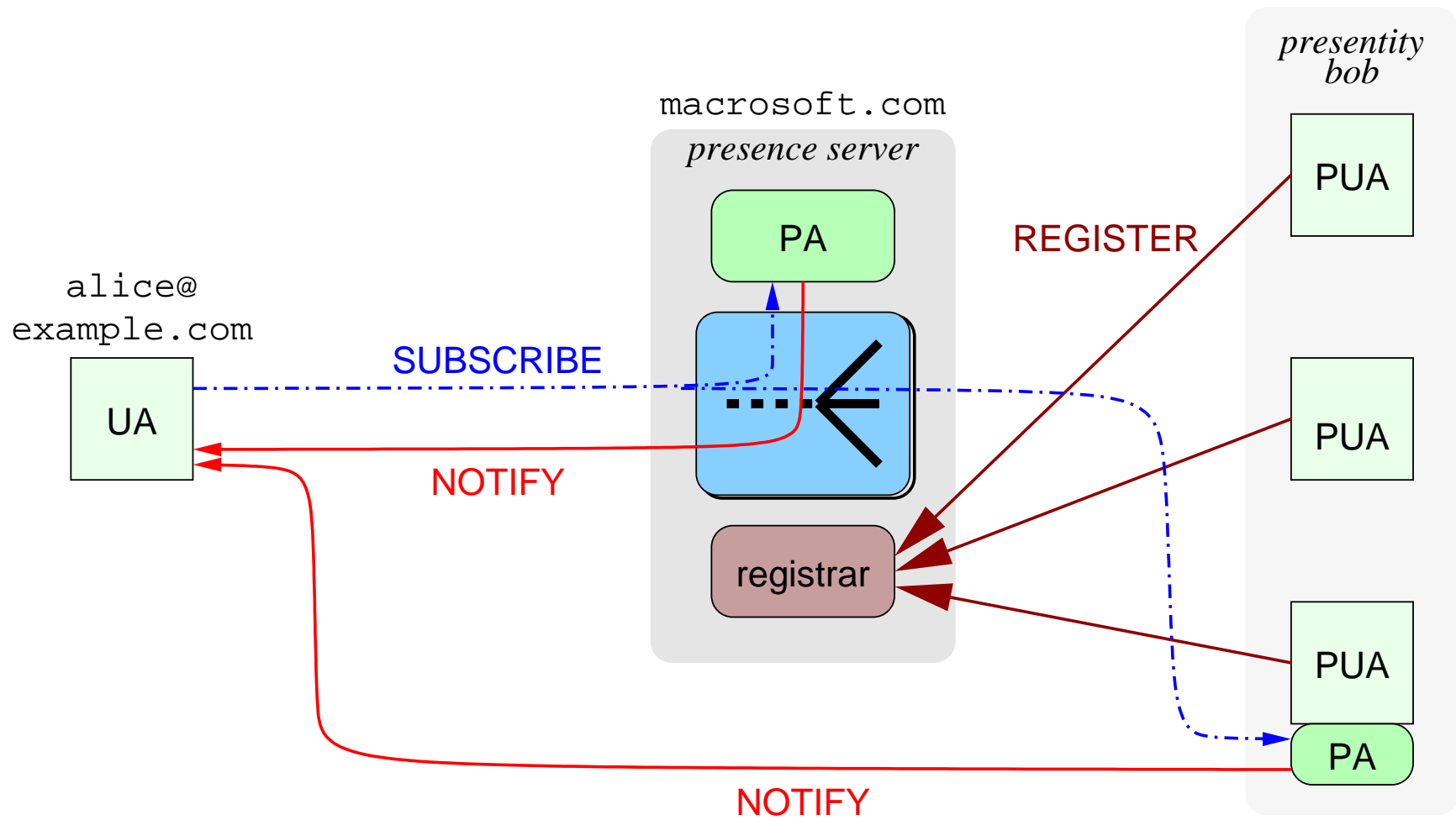

SIP presence components

Presentity: logical entity being subscribe to, e.g., alice@wonderland.com, with several agents

Registrar: receives REGISTER requests

Presence user agent (PUA): generates REGISTER, but no SUBSCRIBE or NOTIFY \Rightarrow any non-presence-aware SIP software

Presence agent: receive SUBSCRIBE, generate NOTIFY

Presence server: SIP proxy + PA

Presence client: SIP UA + PA

SIP presence protocol

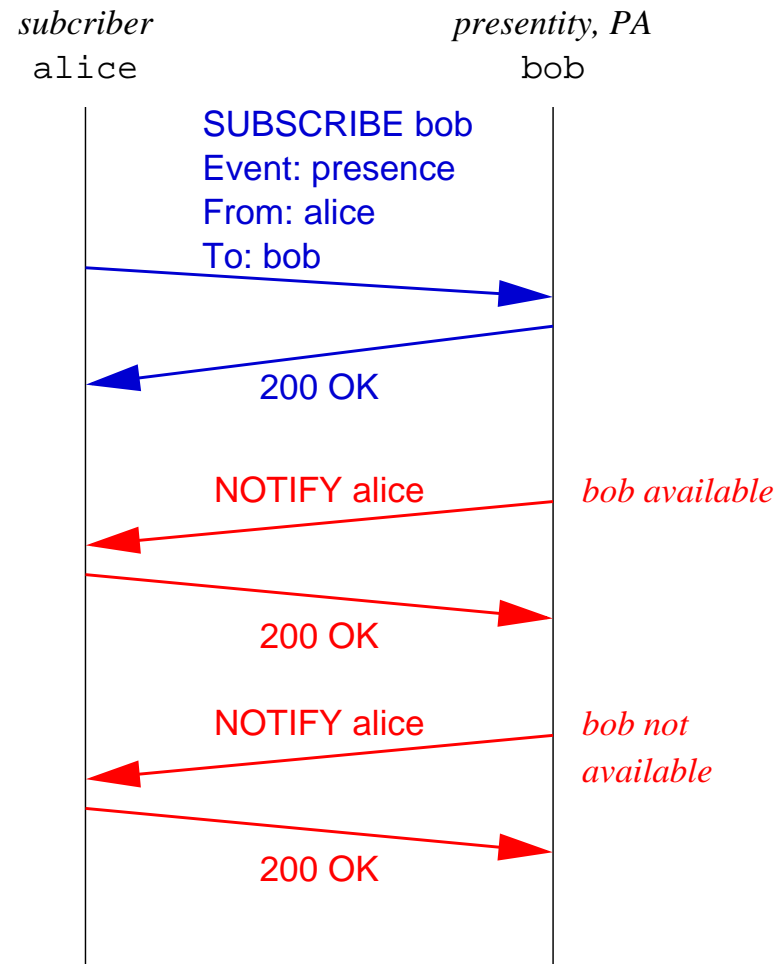

SIP SUBSCRIBE example

```
SUBSCRIBE sip:bob@macrosoft.com SIP/2.0
Event: presence
To: sip:bob@macrosoft.com
From: sip:user@example.com
Contact: sip:user@userpc.example.com
Call-ID: knsd08alas9dy@3.4.5.6
CSeq: 1 SUBSCRIBE
Expires: 3600
Content-Length: 0
```

- Forked to all PUAs that have REGISTERed with method SUBSCRIBE.
- 200 (OK) response contains current state.

SIP NOTIFY example

```
NOTIFY sip:user@userpc.example.com
To: sip:user@example.com
From: sip:alice@wonderland.com
Call-ID: knsd08alas9dy@3.4.5.6
CSeq: 1 NOTIFY
Content-Type: application/xpidf+xml
```

```
<?xml version="1.0"?>
<!DOCTYPE presence
  PUBLIC "-//IETF//DTD RFCxxxx XPIDF 1.0//EN" "xpidf.dtd">
<presence>
  <presentity uri="sip:alice@wonderland.com;method="SUBSCRIBE">
    <atom id="779js0a98">
      <address uri="sip:alice@wonderland.com;method=INVITE">
        <status status="closed"/>
      </address>
    </atom>
  </presentity>
</presence>
```

SIP events

- single-valued (light-switch) to complex (CD changer) to multi-valued (temperature samples)
- both built-in and mediated (X10)
- often combined with audio/video in same system: security, industrial control, home entertainment
- notification rates vary \rightsquigarrow gradual transition to continuous media

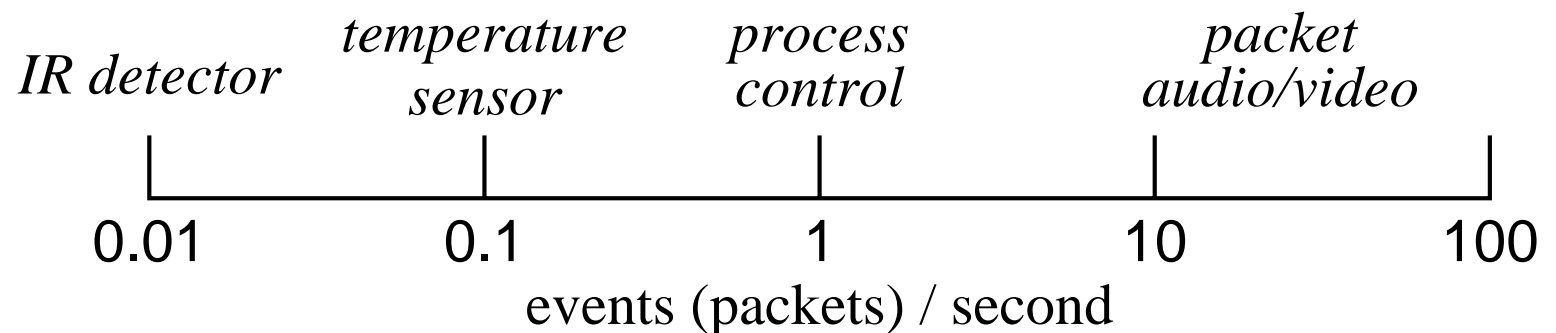

- Event describes event type

Example home architecture

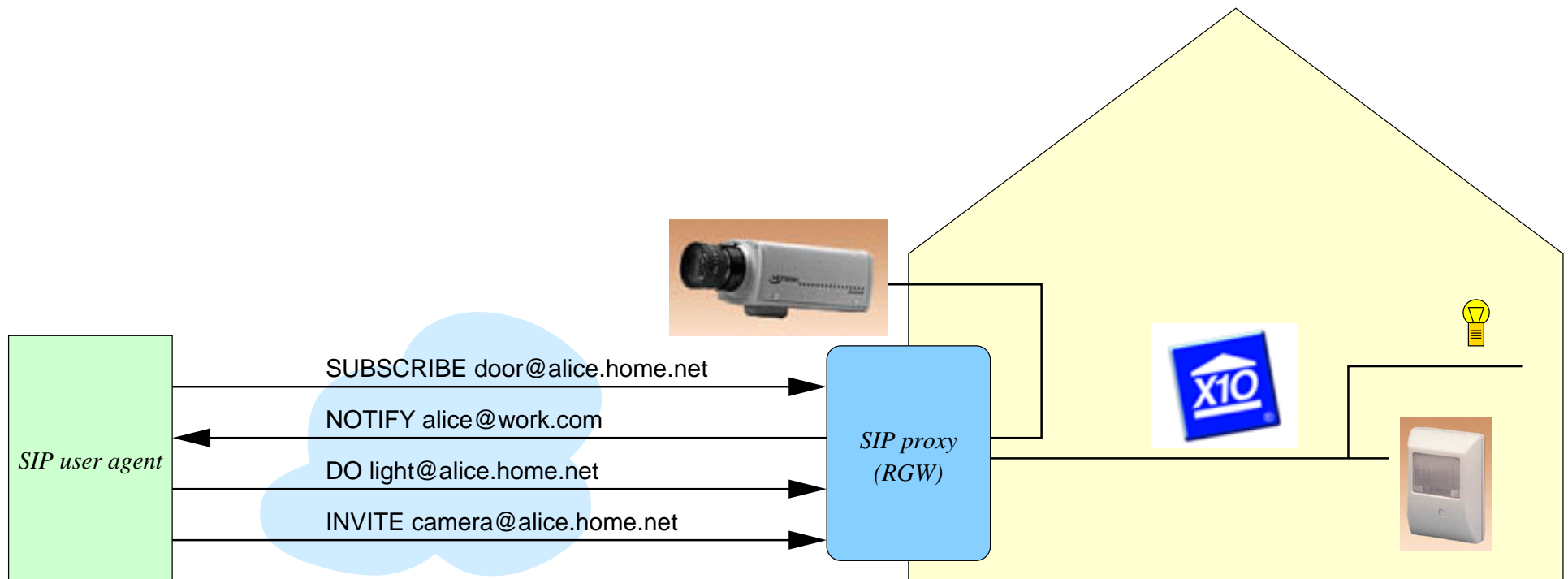

(Work with Telcordia)

SIP IM

- send text or any other MIME type
- either as SDP-initiated session or as individual messages
- use MESSAGE

Programming SIP Services

Programming SIP services

	safety	language?	party?
SIP-cgi	same as scripting	any	callee
servlets	same as Java	Java	callee
CPL	very	XML	both
applets	same as Java	Java	caller

Programming services

- “caller proposes, callee disposes, administrator decides”
- web = static pages → cgi-bin → Java
- “if somebody is trying to call for the 3rd time, allow mobile”
- “try office and lab in parallel, if that fails, try home”
- “allow call to mobile if I’ve talked to person before”
- “if on telemarketing list, forward to dial-a-joke”
- phone: CTI = complex, not generally for end users

cgi-bin for SIP Servers

- extend SIP user/proxy/redirect server functionality without changing server software
- server manages retransmission, loop detection, authentication, ...
- Perl, Tcl, VB scripts

Examples

- Call forward on busy/no answer
- Administrative screening (firewall)
- Central phone server
- Intelligent user location
- Third-party registration control
- Calendarbook access
- Client billing allocation (lawyer's office)
- End system busy
- Phone bank (call distribution/queueing)

cgi Script Functionality

called for any method except ACK or CANCEL

- proxying of requests
- returning responses
- generate new requests

once for each request or response or timeout

cgi Script Mechanism

environment variables: headers, methods, authenticated user, ...

stdin: body of request

stdout: new request, meta-requests:

- CGI- requests for proxying, response, default action
- script cookie for state across messages
- reexecute on all, final response, never

Cgi Example: Call Forwarding

```
use DB_File;
sub fail {
    my($status, $reason) = @_ ;
    print "SIP/2.0 $status $reason\n\n";
    exit 0;
}

tie %addresses, 'DB_File', 'addresses.db'
    or fail("500", "Address database failure");
$to = $ENV{'HTTP_TO'};
if (! defined( $to )) {
    fail("400", "Missing Recipient");
}
```

```
$destination = $addresses{$to};  
  
if (! defined( $destination )) {  
    fail("404", "No such user");  
}  
  
print "CGI-PROXY-REQUEST-TO $destination SIP/2.0\n";  
print "CGI-Reexecute-On: never\n\n";  
untie %addresses; # Close db file
```

The Call Processing Language

Jonathan Lennox
Columbia University
lennox@cs.columbia.edu

May 5, 2000

Purpose

Allow users to create simple Internet telephony services

Features:

- Creatable and editable by simple graphical tools
- Independent of signalling protocol
- Safe to run in servers

Abstract structure

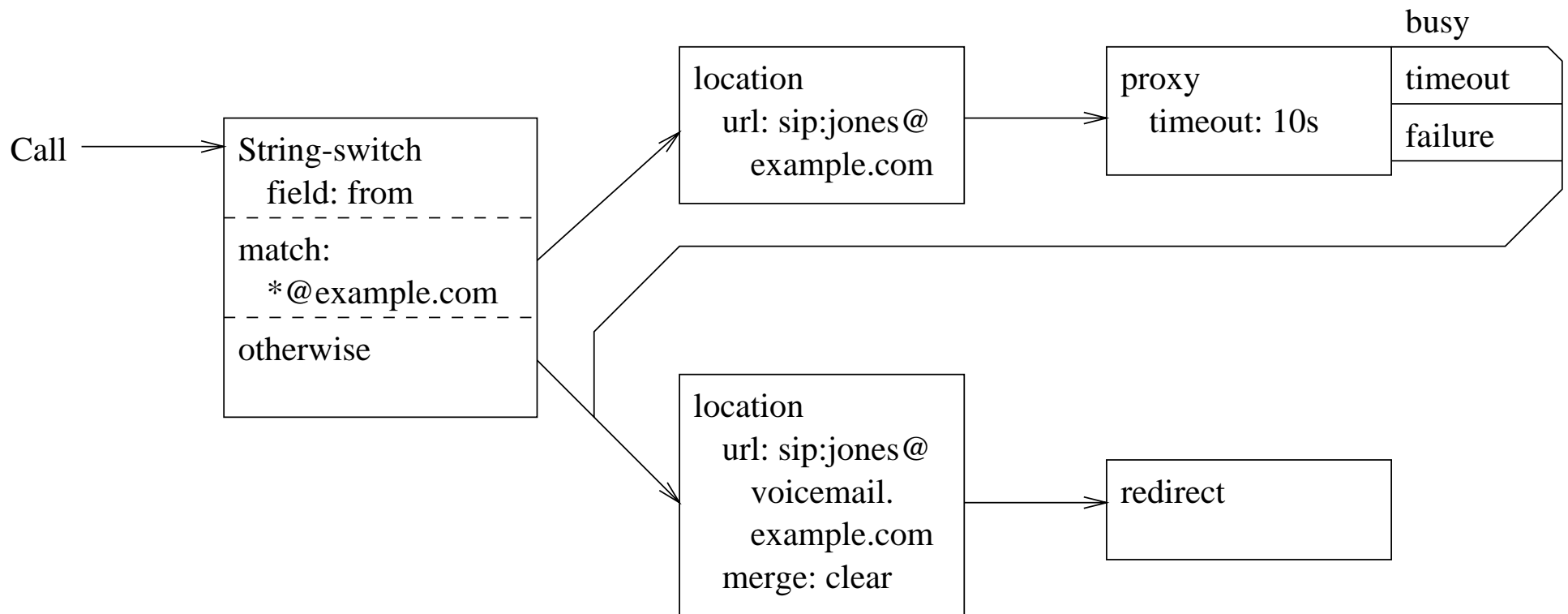

Abstract structure (cont)

- Nodes and outputs — “boxes” and “arrows”
- Nodes have parameters
- Start from single root “call” node
- Progress down tree of control
- May invoke sub-actions
- Follow one output of each node, based on outcome
- Continue until we get to a node with no outputs

Textual representation

```
<cpl>
  <subaction id="voicemail">
    <location url="sip:jones@voicemail.example.com">
      <redirect />
    </location>
  </subaction>
```

Textual representation

```
<incoming>
  <address-switch field="origin" subfield="host">
    <address subdomain-of="example.com">
      <location url="sip:jones@example.com">
        <proxy>
          <busy> <sub ref="voicemail" /> </busy>
          <noanswer> <sub ref="voicemail" /> </noanswer>
          <failure> <sub ref="voicemail" /> </failure>
        </proxy>
      </location>
    </address>
    <otherwise>
      <sub ref="voicemail" />
    </otherwise>
  </address-switch>
</incoming>
</cpl>
```

Textual representation

- Represent scripts as XML documents
- Incoming, outgoing scripts are separate top-level tags
- Nodes and outputs are both tags
- Parameters are tag attributes
- Multiple outputs to one input represented by subactions

Switch nodes

Switch nodes make decisions.

Structure:

```
<type-switch field=var>
  <type condition1="value1">
    action1
  </type>
  <type condition2="value2">
    action2
  </type>
  <not-present>
    action3
  <otherwise>
    action4
  </otherwise>
</type-switch>
```

Address Switches: address

Switch based on textual strings:

is: (exact string match)

contains: substring match: only for “display”

subdomain-of: domain match: only for “host”, “tel”

Fields are “origin,” “destination,” “original-destination”, with subfields “address-type,” “user,” “host,” “port,” “tel,” “display”

String Switches: `string`

Switch based on textual strings, with conditions:

is: exact string match

contain: substring match

Fields: `subject`, `organization`, `user-agent`

Time switches: `time`

Switch based on the current time at the server.

timezone: which timezone the matching should apply in

Conditions:

- year, month, date, day, timeofday
- each condition is a list of ranges: $a_1 - b_1, a_2 - b_2, \dots$
- must fall within a range of *all* specified conditions

Time switches: examples

```
<time month="12" date="25" year="1999">
```

December 25th, 1999, all day

```
<time month="5" date="4">
```

May 4th, every year, all day

```
<time day="1-5" timeofday="0900-1700">
```

9 AM – 5 PM, Monday through Friday, every week

Time switches: examples

```
<time timeofday="1310-1425,1440-1555,1610-1725"  
      day="2,4">
```

1:10 – 2:25 PM, 2:40 – 3:55 PM, and 4:10 – 5:25 PM, Tuesdays and Thursdays,
every week

```
<time date="1-7" day="1">
```

The first Monday of every month, all day

Location nodes

- A number of CPL actions (proxy, redirect) take locations
- *Location nodes* let you specify them
- These are full-featured nodes because we might want to make decisions based on outcomes of location lookups, or cascade locations
- A CPL script has an implicit global list of locations
- Location nodes can add to this list, or clear the list

Simple location nodes: location

Specify a location explicitly.

url: explicitly specified location

clear: clear earlier location values

Only one output; cannot fail. Don't use an explicit output node in the URL.

Location lookup nodes: `lookup`

Specify a location abstractly, by where it should be looked up.

Parameters:

source: URL (ldap, http (CGI), etc) or non-URL source (“registration”) to search for locations

timeout: time to wait

use/ignore:

- use: caller-preferences parameters to use
- ignore: caller-preferences parameters to disregard

merge:

Outputs: `success`, `notfound`, `failure`

Location removal nodes: `remove-location`

Remove locations from the location set, based on caller preferences/callee capabilities. Has the same effect as a “Reject-Contact” header.

param: caller preference parameters to apply

value: values of parameters specified in “param”

location: caller preference location to apply

Signalling Actions: proxy

Proxy the call to the currently-specified set of locations, and automatically select one “best” final response.

timeout: time before giving up on the proxy attempt

recurse: recurse on redirect responses to the proxy attempt?

ordering: try location in parallel, sequential, first-only

- Outputs: busy, noanswer, failure
- If the proxy attempt was successful, script terminates

Signalling Actions: `redirect`

Redirect the call to the currently-specified set of locations. This has no specific parameters, and causes the script to terminate.

Signalling Actions: `reject`

Reject the call attempt. This causes the script to terminate.

status: “busy,” “notfound,” “reject,” or “error”, or a 4xx, 5xx, or 6xx code (for SIP).

reason: string explaining the failure.

Non-signalling action: mail

Notify a user of something through e-mail.

url: the address to contact, including any header parameters.

Non-signalling action: log

Store a record of the current call in a log.

name: the name of the log this should be stored

comment: a string explaining the log entry

Outputs: success, failure

Subactions

- XML syntax defines a tree; we want CPLs to be represented as directed acyclic graphs.
- *Subactions* are defined at the top level of the script, outside other actions.
- for acyclicity, top-level actions and subactions may only call subactions which were defined earlier in the script.
- Anywhere a node is expected, you can instead have a `sub` tag, with a `ref` parameter which refers to a subaction's id.

Example: Call Redirect Unconditional

```
<cpl>
  <incoming>
    <location url="sip:smith@phone.example.com">
      <redirect />
    </location>
  </incoming>
</cpl>
```

Example: Call Forward Busy/No Answer

```
<cpl>
  <subaction id="voicemail">
    <location url="sip:jones@voicemail.example.com" >
      <proxy />
    </location>
  </subaction>

  <incoming>
    <location url="sip:jones@jonespc.example.com">
      <proxy timeout="8s">
        <busy>
        </busy>
        <noanswer>
          <sub ref="voicemail" />
        </noanswer>
      </proxy>
    </location>
  </incoming>
</cpl>
```

Example: Call Screening

```
<cpl>
  <incoming>
    <address-switch field="origin" subfield="user">
      <address is="anonymous">
        <reject status="reject"
          reason="I don't accept anonymous calls" />
      </address>
    </address-switch>
  </incoming>
</cpl>
```

Example: Time-of-day Routing

```
<?xml version="1.0" ?>
<!DOCTYPE call SYSTEM "cpl.dtd">

<cpl>
  <incoming>
    <time-switch timezone="US/Eastern">
      <time day="1-5" timeofday="0900-1700">
        <lookup source="registration">
          <success>
            <proxy />
          </success>
        </lookup>
      </time>
    <otherwise>
      <location url="sip:jones@voicemail.example.com">
        <proxy />
      </location>
    </otherwise>
  </time-switch>
</incoming>
</cpl>
```

Example: Non-call Actions

```
<?xml version="1.0" ?>
<!DOCTYPE call SYSTEM "cpl.dtd">

<cpl>
  <incoming>
    <lookup source="http://www.example.com/cgi-bin/locate.cgi?user=jones"
           timeout="8">
      <success>
        <proxy />
      </success>
      <failure>
        <mail url="mailto:jones@example.com&Subject=lookup%20failed" />
      </failure>
    </lookup>
  </incoming>
</cpl>
```

SIP for Third-Generation Wireless Networks

3G networks

- successor to 2G mobile networks: GSM (TDMA) and IS-95 (CDMA) in 900/1800 MHz range
- 2.5G: GSM → GPRS → EDGE
- use different air interfaces in 2 GHz range: W-CDMA, CDMA 2000, TD-CDMA
- 3GPP standardizes for W-CDMA (GSM follow-on), while 3GPP2 does CDMA 2000
- identified by releases (1999, R4, R5)

3G and VoIP

- GPRS not suitable for VoIP: low bandwidth, high delay (500-600 ms RTT)
- initially (R4), CS voice to base station, then ATM/IP packets
- later (R5), in *Internet multimedia* (IM) subsystem → IP to UE (user equipment)
- uses AMR audio codec, with variable rate of 4.75 to 12.2 kb/s, or GSM HR or EFR
- UTRAN delays: see TR 25.932

Signaling in 3GPP IM subsystem

Uses SIP for session setup and defines new entities:

Proxy CSCF: first point of contact in visited network; finds the user's home network and provide some translation, security and authorization functions

Serving CSCF: controls sessions, acts as registrar and triggers and executes services. Accesses the user's profile; can be located in the home or visited network.

Interrogating CSCF: first point of contact in home network. It assigns the serving CSCF, contacts the HSS and forwards SIP request.

3G SIP registration

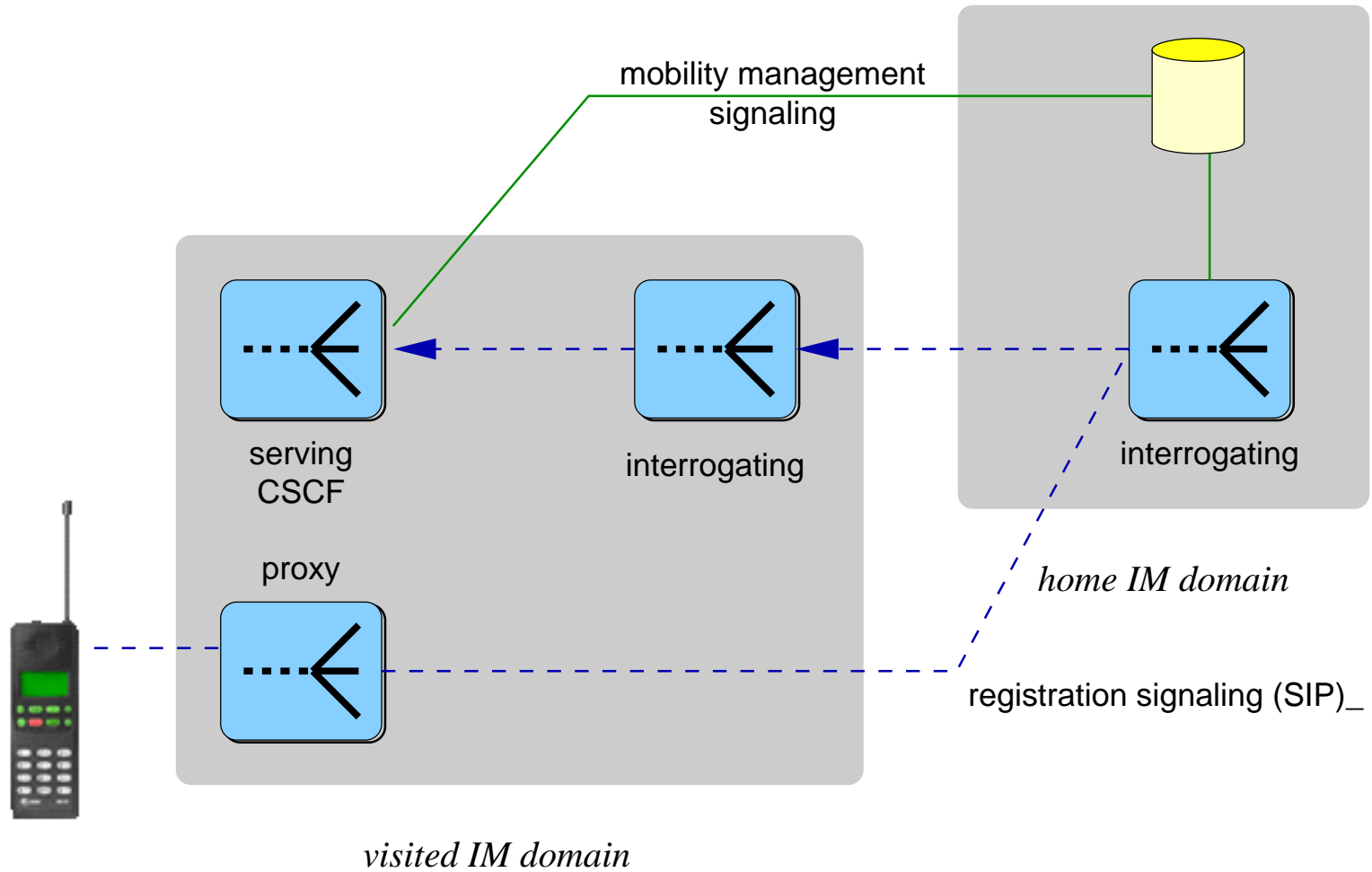

Differences to “standard” SIP

- requires REGISTER before making call
- INVITE uses authentication information provided by REGISTER ➡ Path header
- always visit I/P/S for “home” services
- compression on link from UE to P-CSCF

RFCs

draft-ietf-sip-rfc2543bis-03	base protocol spec
RFC 3087	<i>Control of Service Context using SIP Request-URI</i>
RFC 3050	<i>Common Gateway Interface for SIP</i>
RFC 2916	<i>E.164 number and DNS</i>
RFC 2833	<i>RTP Payload for DTMF Digits, Telephony Tones and Telephony Signals</i>
RFC 2806	<i>URLs for Telephone Calls</i>
RFC 2543	<i>SIP: Session Initiation Protocol</i>

For more information...

SIP: <http://www.cs.columbia.edu/sip>

SDP: <http://www.cs.columbia.edu/~hgs/internet/sdp.html>

RTP: <http://www.cs.columbia.edu/~hgs/rtp>

Papers: <http://www.cs.columbia.edu/IRT>