

December 2004

# WHITE PAPER

## Public Ethernet for profitable broadband

Enabling IP multi-service access for universal penetration

# Contents

- 1            Executive summary ..... 3**
- 2            Broadband multi-service architecture drivers ..... 4**
- 3            Key characteristics of Public Ethernet ..... 5**
- 4            The architecture of Public Ethernet ..... 7**
  - 4.1        *Reference architecture of the Public Ethernet network* ..... 7**
  - 4.2        *Functional architecture* ..... 8**
- 5            Multi-service support in Public Ethernet ..... 10**
  - 5.1        *Implementing multi-service access in Public Ethernet* ..... 11**
  - 5.2        *Role of BRAS in service access* ..... 12**
- 6            Security in Public Ethernet ..... 13**
- 7            Cost efficiency and scalability ..... 14**
- 8            Migrating to Public Ethernet ..... 15**
- 9            Managing Public Ethernet ..... 16**
- 10          True multi-service broadband access solution ..... 17**
- 11          Abbreviations ..... 17**

# 1 Executive summary

Public Ethernet is a network architecture based on Ethernet technology and enhanced with a number of features in order to provide telecom grade quality to large public networks. It combines the best of today's voice services and reliability with broadband data and entertainment services, flexibility and the open interfaces associated with a multi-vendor environment.

Public Ethernet enables operators to provide broadband services above and beyond "best-effort" internet access connectivity. And it helps them meet new demands on the first and second miles of a provider's access network. Network providers looking for maximum return on investment need a solution that is cost efficient, and allows them to increase penetration and introduce additional services with the help of internet access.

Public Ethernet solutions meet these needs. They are scalable, flexible and support new services and new relationships with service providers. They also integrate smoothly with existing management and business support systems, and minimize time-to-service without disrupting established revenue streams.

DSL Forum has already defined the architectural requirements for moving from best-effort internet access connectivity to an IP multi-service environment. The challenge for operators is to select the best way to implement these requirements when building the actual network. Until now, ADSL and end-to-end ATM access networks have dominated operators' broadband strategies. Today, however, this strategy needs to be revised for the next phase of the broadband rollout.

In traditional LAN networks Ethernet is simply used to provide best effort transportation, whereas Public Ethernet, based on IP and Ethernet, is a sound foundation for future-proof DSL and fiber networks. Public Ethernet meets the operators' expectations of large public access networks in terms of e.g. network availability and manageability. It will enable an economical introduction of "triple play" services, this being fundamental in order to attract future customers.

We believe that acceptance of this technology will be accelerated when operators now introduce IP-DSLAMs with ADSL2plus into the access network and Gigabit Ethernet into the aggregation network.

## 2 Broadband multi-service architecture drivers

Current broadband internet access services are characterized by “best-effort” Quality of Service (QoS), usually with a flat-rate price structure, and with raw access bandwidth as the only real service differentiator. Stiff competition between providers has driven down the price for end-users. The battle now is to establish a sustainable customer base. The first provider to bundle video, data and telephony services in an attractive “triple play” offer will attract the most customers and create a viable base from which to build. Providers offering just one or two services are likely to lose their customers and will have difficulty regaining them later.

Consequently the future of broadband access networks is much more than just fast internet connectivity. The growth in the number of applications is continually increasing the requirements on network bandwidth and QoS (e.g. video services). The ability to increase bandwidth has attracted a lot of attention from providers and resulted in a number of standards, both for DSL and fiber access. However, to enable a true multi-service network, the improvements in obtainable bandwidth in the first mile must be complemented by substantial capacity improvements in the second mile. Furthermore, end-to-end QoS and network availability must be ensured all the way from the end-user to the application service provider. Access providers are investigating how new applications can create new revenue opportunities. Figure 1 shows how the various drivers stimulate broadband access deployment, bringing increased revenue options for providers.

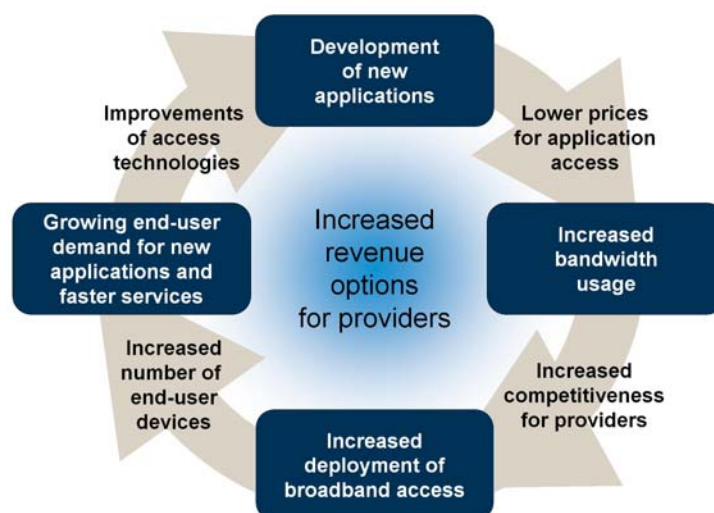

Figure 1. Drivers toward a broadband multi-service architecture

Increased broadband penetration and faster services have boosted the development of both new applications and broadband transmission technology. Applications include high-speed internet access, audio and video streaming, on-line gaming, telephony and virtual private networks for telecommuters and enterprises.

Application development is also being driven by the growth in the number of networked devices in the home, which in turn increases traffic volumes and forms the basis for still more applications. Besides the traditional desktop PC, a wide range of other connected devices, such as IP telephones, set-top boxes and game consoles are becoming popular.

### 3 **Key characteristics of Public Ethernet**

Public Ethernet is designed to meet requirements such as increasing network bandwidth, QoS and manageability in order to provide more services and applications. It brings applications to end-users, taking advantage of Ethernet technology. Ethernet serves as the transport mechanism between end-users and the access provider, tying end-users' home networks to the access network.

Ethernet is the natural choice for transporting Internet Protocol (IP); it is believed that more than 90 percent of all IP traffic originates and terminates in Ethernet networks. The Public Ethernet network itself relies on IP technology: all management traffic uses IP, and Ethernet Access Nodes are able to perform security filtering and manipulation of IP traffic to and from end-users.

Real-time applications, such as IP telephony and on-line gaming, require low latency in the network whereas bandwidth-hungry applications, such as on-demand video, increase the bandwidth demands significantly. Public Ethernet enables broadband networks to handle all these requirements cost efficiently, today and in the future.

The key features that make Public Ethernet successful include cost efficient equipment, improved provisioning and maintenance, and scalability. These benefits are retained when deploying Ethernet technology for broadband access.

Ethernet has continuously been re-invented in the past 30 years and is now moving into public networks with the 10GbE and Ethernet-in-the-First-Mile (EFM) standards. These introduce e.g. improved availability and manageability, Ethernet over DSL (no ATM) and single bi-directional fiber in the local loop. Public Ethernet is being developed by carefully choosing the best features of this technology and creating a solution that offers the benefits of a traditional telecom network (telecom-grade QoS, manageability), while maintaining the cost efficiency of Ethernet.

The key characteristics enhancements of Public Ethernet:

#### Multi-service ability

Public Ethernet is a true multi-service enabler for broadband access. This includes the ability for each end-user to access multiple applications simultaneously, via different service providers, and with the QoS to ensure that the most sensitive and profitable services are prioritized.

#### Security

Public Ethernet uses several mechanisms for ensuring security and privacy for end-user data carried over the access network, as well as for protecting network equipment from outside attacks. Some of these mechanisms are based on established standards (such as virtual LANs) whereas others are enhancements to provide telecom-grade levels for services and security.

#### Standards

Public Ethernet is interoperable with other network solutions, using open-standard protocols and well-proven technologies. The standards used as the basis for Public Ethernet architecture are: Ethernet as standardized by IEEE for switching and ITU-T and IETF standards for all other areas.

#### Cost and scalability

The use of switched Ethernet technology provides a cost-efficient solution for broadband access, especially when compared with traditional ATM-centric solutions. At the same time, Public Ethernet proves to have superior scalability, making access networks of different sizes profitable, and allowing a seamless transition from smaller to larger networks as broadband penetration and bandwidth requirements increase.

#### Migration from legacy networks

Many incumbent providers have invested heavily in transport networks based on traditional technologies such as ATM and SDH. Public Ethernet allows these providers to reuse their backbone investments as an integrated part of their broadband solutions, either as the sole transport network or as a complementary transport network in parallel with other transport and access solutions.

#### Network availability

A non-operational network does not generate revenues, so maximizing network availability is vital for any service provider. Public Ethernet has a number of mechanisms and protocols to provide robustness and resilience in the access network.

Network manageability

Public Ethernet solutions comprise tools for managing the entire access network, and standard interfaces for integrating the Public Ethernet network with existing network management and business support systems.

It can be concluded that there are a number of key differentiators, comparing with “regular Ethernet”, which Public Ethernet adds in order to build a scalable public network.

## 4 The architecture of Public Ethernet

The architecture of Public Ethernet need to be described as a physical network as well as from a functional point of view, as in the following two sections.

### 4.1 *Reference architecture of the Public Ethernet network*

A Public Ethernet-based access solution is depicted in Figure 2. The Public Ethernet portfolio primarily targets the access and regional network areas in this architecture.

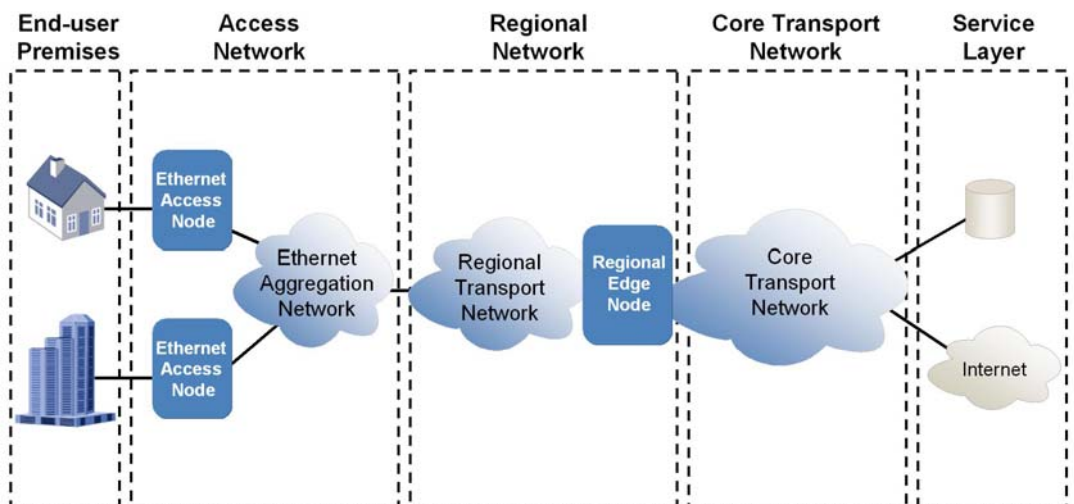

*Figure 2. Network reference architecture*

The access network comprises the Ethernet access nodes and an aggregation network based on switched Ethernet technology. The aggregated Ethernet traffic may be carried over a regional Ethernet transport network. During a transitional period there is a possibility to use transport means other than

native Ethernet, such as PDH, SDH or ATM, but then only for voice and data. The regional transport network may also be a metro Ethernet ring. The regional network terminates in a Regional Edge Node, such as a Broadband Remote Access Server (BRAS), an IP router or an Ethernet switch. Network service providers and application service providers interface with the Regional Edge Node, often via a core transport network.

As in any access network, the basic objective is to provide end-users with connectivity towards the service layer. This means connectivity is a service provided to end-users, creating a logical connection – a service binding – between an end-user device and a network service or application.

## 4.2 **Functional architecture**

The role of Public Ethernet can also be described using a layered model, as shown in Figure 3. As indicated, the solution comprises three main functional areas: transmission technology, access/network services and management. The end-user services are carried over the Public Ethernet infrastructure using various services and technologies.

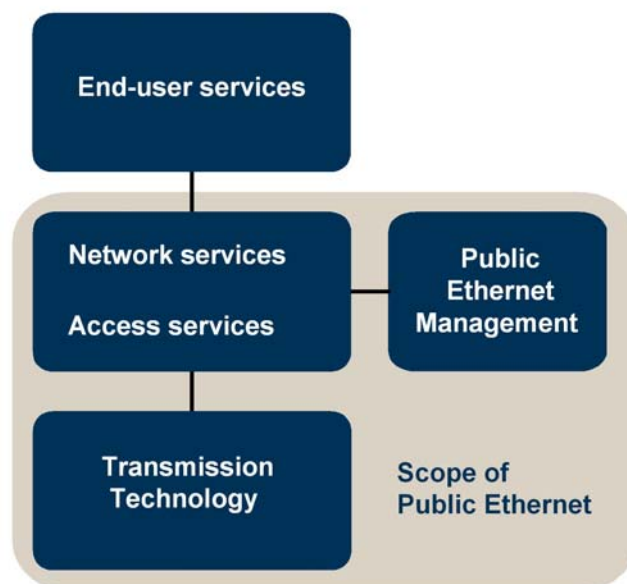

*Figure 3. The scope of Public Ethernet*

The top layer of the Public Ethernet model in Figure 3, end-user services reflects real values requested by end-users. Using the DSL Forum's definition, these are service offerings as experienced by the end-user via a device with a user interface (such as audio, visual display screen, joystick or remote control), at the customer premises. Examples of end-user services include web access,



IP telephony, video streaming (TV, video on demand, conferencing etc) and network gaming.

The lowest layer, transport technology, deals with the physical infrastructure of the network and how information is transported across the network. The key transmission technology for Public Ethernet is Ethernet, or rather switched Ethernet, as standardized by IEEE 802.3.

Between the end-user-services layer and the transmission layer in Figure 3 are access/network services. In the Public Ethernet context, these deal primarily with establishing service bindings. A service binding has a number of attributes, including the binding method and QoS characteristics.

In a traditional Ethernet (LAN) environment, such as an office or home, the service layer is virtually non-existent. Ethernet technology is simply used to provide a cost-effective solution for interconnecting networked devices such as PCs and printers. End-user services are executed over the LAN, which offers a single QoS level, where all devices compete for the available bandwidth.

However, the network/access service layer of Public Ethernet has a range of new responsibilities corresponding to the previously described key characteristics of the solution. In other words, in Public Ethernet the service layer must also ensure multi-service support, QoS, security, resilience and so on, in order to create a telecom-grade broadband access system based on Ethernet.

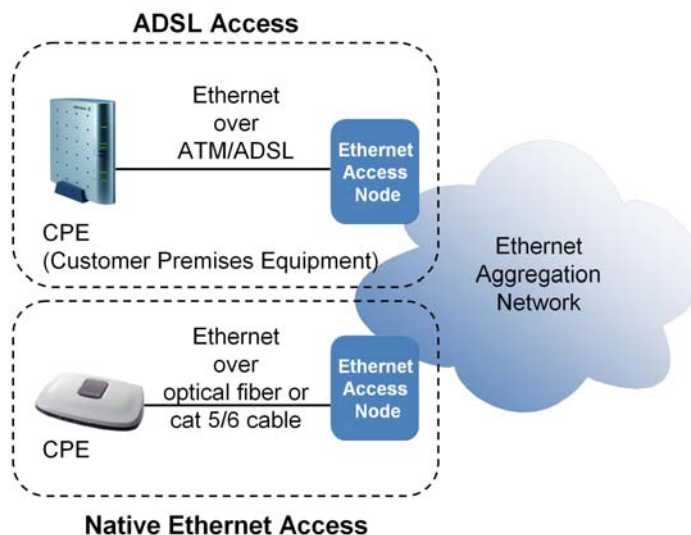

Figure 4. First-mile technologies in Public Ethernet

Public Ethernet utilizes various physical media for conveying Ethernet over the first mile: cat5/6 cable, optical fiber or local loop wires (twisted pair - cat3) as

shown in Figure 4. For cat5/6 cable and optical fiber the Ethernet protocol data units are carried directly over the physical media.

For local loop wires, ADSL2 and ADSL2plus technology is used. This includes the use of ATM as the intermediate layer, between Ethernet and ADSL, to ensure interoperability with existing ADSL modems (EFM is also standardizing Ethernet over DSL without ATM). If ATM is used in the first mile and Ethernet in the second mile, the access nodes ensure proper transformation between the two technologies. A Public Ethernet access network may deploy all these drop technologies simultaneously in the one integrated system.

## 5 Multi-service support in Public Ethernet

Supporting the delivery of multiple services is a cornerstone of Public Ethernet. It enables the access service provider to design and deploy services with a QoS profile that matches the requirements of the applications running over it. However, this ability to offer different service qualities must be complemented with a number of other system properties to create a true multi-service network architecture.

The fundamentals of Public Ethernet supporting multi-service delivery are as follows:

Public Ethernet supports **multiple access service providers** offering their services to all end-users on equal terms: a basic prerequisite for offering many-to-many access.

Public Ethernet supports **many-to-many access**, enabling multiple users to utilize a single physical access connection (such as the local loop) to access more than one access service provider simultaneously. This means that, from a single end-user's premises, **multiple service bindings** can be established with different providers.

Public Ethernet supports multiple applications over the same physical end-user connection, with **different QoS and bandwidth profiles for each application**. Different applications can have quite different requirements. Consequently, the access network must treat applications according to their service needs, giving preferential treatment to, for example, real-time applications such as telephony. Some applications, such as internet access, may also be offered with different service characteristics, including different bandwidths or service guarantees.

Public Ethernet supports **any kind of application** and combination of different applications, targeting both residential and business users. A business user's service requirements are not the same as those of a residential user. Business users generally have much higher requirements and expect guaranteed

service and network resilience. In addition, these services traditionally represent good revenue opportunities for providers.

Public Ethernet supports **AAA functionality** (Authentication, Authorization, Accounting), enabling differentiated access to applications and charging according to the specific service and application provided.

Traditional ATM-centric broadband access systems can not compete cost efficiently with these properties of Public Ethernet. The DSL Forum has identified the major evolutionary requirements for access architectures in its document Multi-Service Architecture and Framework Requirements<sup>1</sup>. The list of required improvements gives the impression that traditional ATM-centric access architectures lack most of the capability and flexibility necessary to meet even basic multi-service requirements. In contrast, Public Ethernet addresses these requirements through the creation of an Ethernet-centric broadband access architecture that fulfills the multi-service requirements posed by the DSL Forum.

## 5.1 ***Implementing multi-service access in Public Ethernet***

In order to provide a multi-service architecture, Public Ethernet supports multiple logical *service channels* in the first mile. The purpose is to ensure that individual services are assigned the appropriate QoS and bandwidth. The implementation of a service channel in Public Ethernet depends on the transport technology used in the first mile: In case of ADSL there is support for multiple ATM Permanent Virtual Connections (PVC) per end-user, where each PVC represents a service channel. In case of Ethernet to the end-user, the service channels are represented by virtual LANs (VLANs).

The access node is interfacing the aggregation network with a common Ethernet interface, this independent of which drop technology is used as illustrated in Figure 4. The service binding in the access node provides basic connectivity to a service node, such as an application server, an IP router or a BRAS. In the latter example, the BRAS complements the basic service binding with an option for dynamic service selection.

The access node performs a service binding between the service channel and a service VLAN. Each end-user service is associated with a specific service VLAN as illustrated in Figure 5.

---

<sup>1</sup> Referenced as Technical Report 58 (TR-058)

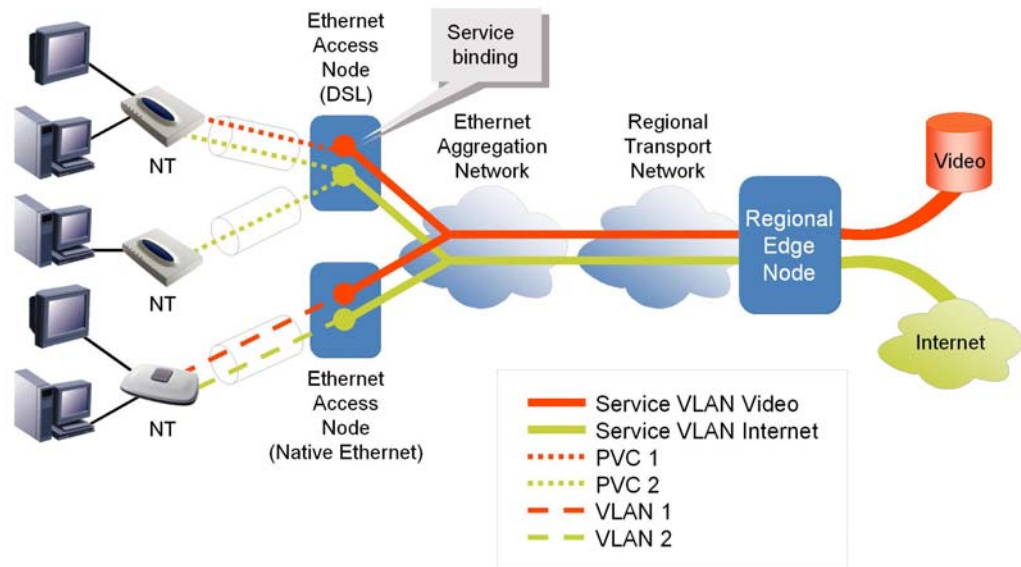

Figure 5. Service binding between service channels and service VLAN

VLAN technology is a cornerstone of the multi-service architecture of Public Ethernet. By using this technology, the switched Ethernet access network is split into logically separated networks, each representing a specific service. VLAN technology is standardized in IEEE802.1Q. Basing the access network on this standard enables prioritization of Ethernet frames within the network.

In summary, the use of service bindings and VLAN ensure that multiple services can be delivered with the quality and availability each of them requires. The adoption of service VLAN in the second mile simplifies network provisioning because end-to-end PVCs are eliminated

## 5.2 Role of BRAS in service access

Multi-service access architecture is traditionally dependent on one or more BRASs for the creation and administration of service bindings. A BRAS is normally located at a central point in the network because it must aggregate traffic from a large number of end-users to minimize the cost per end-user. In a typical ATM access scenario, end-users log into the BRAS using the Point-to-Point Protocol (PPP), and their login credentials are used both to validate the end-user's identity and determine the requested service. Public Ethernet fully supports this architecture. A BRAS may be used to perform a number of functions, including a wide range of access protocols, tunneling, Virtual Private network (VPN), full IP routing, Multi Protocol Label Switching (MPLS), QoS shaping and policing, and AAA.

The BRAS may be complemented with a policy server, which dynamically allocates traffic capabilities per IP session to end-users. The policy server allows end-users to change their service profiles dynamically within the BRAS, by, for example, changing bandwidth or QoS settings.

The Public Ethernet network supports one or more BRASs, located in different service VLANs. In some scenarios, however, the basic service binding created in the Ethernet Access Node may be considered sufficient to manage end-user access to applications. Such cases do not require BRAS functionality; instead, a service node may interface directly with its corresponding service VLAN in the access network. This approach has certain advantages:

- The BRAS is offloaded or simply not needed.
- Applications are easily added to the network. In principle, any type of service node can be connected in this way.
- The service nodes may be placed locally in conjunction with the access network, minimizing the traffic load on the transport network and reducing transmission delay for real-time applications. An example is that for the distribution of video. The video content is stored in a local server, which streams the signal into the access network within the service VLAN assigned for this video service.

Public Ethernet offers the possibility to locate BRASs wherever in the networks they are best suited, either due to traffic planning or logistic reasons. Both the option with and without BRASs can co-exist seamlessly in a single Public Ethernet access network.

## 6 Security in Public Ethernet

All networks are susceptible to attacks from both external and internal parties. The attacks can have many forms including information theft, denial-of-service attacks and corruption of programs or information.

A traditional Ethernet network is based on broadcast media, as opposed to the circuit-oriented architecture of legacy access systems which is based on e.g. ATM. Public Ethernet consequently uses several mechanisms for separating different traffic types, ensuring the privacy and integrity of the transported data and protecting the equipment owned by subscribers and providers.

The following examples give a simplified view of Public Ethernet security functionality implementations.

Traffic separation with virtual LAN: Different traffic types are logically separated in different domains in the Ethernet network. A typical example is to

separate the operator's management traffic and the subscriber traffic in different VLANs so subscribers can not interfere with the operator's own traffic.

Separate end-users within a VLAN: To avoid "peer-to-peer" connections between end-users, a technique based on Media Access Control (MAC) addresses can route all traffic to a router in such a way that the operator can control the traffic. In the event certain protocols, such as PPP, are used, special filter rules can be applied to ensure that traffic passes the router.

End-user identification: There are special ways to identify which port, or line, in the access node specific traffic originates from, so operators can trace malicious users, for example.

Virtual addressing: Introducing virtual addresses, fully controlled by the operator, solves the problems of end-users tampering with their unique address (MAC address) to pretend they are someone else, or several items having identical addresses.

Filtering: Filters can be applied to, for example, prevent end-users using false IP addresses, known as IP spoofing.

Where a traditional LAN Ethernet network provides a low level of security, the Public Ethernet has implemented a number of features to meet the demands of large public networks.

## 7 Cost efficiency and scalability

Public Ethernet focuses on minimizing both capital and operational expenditure, making it possible for providers to offer attractive services and applications at competitive prices.

The use of Ethernet technology is a major factor in the cost efficiency of Public Ethernet. Ethernet technology has proven itself successful in LAN environments where it is now a dominant technology. Key features behind its success are a low price-performance ratio for equipment together with improvements in provisioning, maintenance and scalability.

As opposed to ATM, an Ethernet network is not connection oriented. Individual traffic flows, therefore, do not need to be pre-configured for the access network. Instead, by inspecting the source addresses of incoming frames, the access network switches quickly build up knowledge about the network topology in order to direct traffic in the right direction. Another advantage is that the bandwidth of the Ethernet access network may effectively be shared between all or a group of end-users, as opposed to the more static bandwidth allocation of ATM-centric systems.

Ethernet technology is particularly well suited as the foundation for a multi-service network architecture. Demanding applications, such as real-time broadcast TV, can be transferred over Ethernet as one multicast stream, instead of having one stream per end-user as in ATM-centric access networks. This conserves precious bandwidth in both the access and transport networks.

High scalability is a major benefit of Public Ethernet. It can be adapted to both very small and large sites. Especially with DSL rollout, downward scalability is often important to create an acceptable business case in rural areas or locations with low DSL penetration. Public Ethernet uses the IP DSLAM for this purpose. The IP DSLAM is a non-blocking Ethernet Access Node for ADSL2/ADSL2plus, enabling every end-user to have up to 24Mbps downstream and 3Mbps upstream.

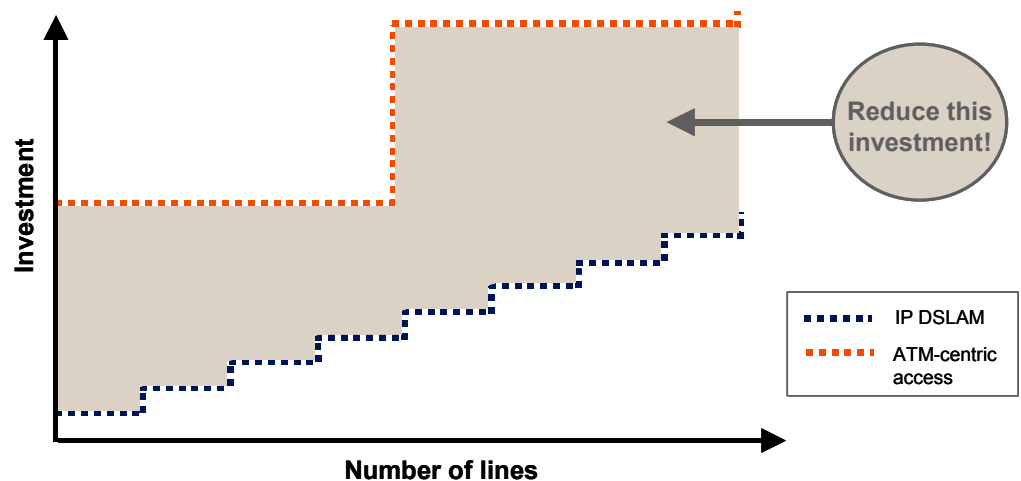

Figure 6. Public Ethernet for best scalability

In conclusion, a provider can have a healthy business case with practically any size access network – ranging from a handful of end-users to tens or hundreds of thousands. As broadband penetration grows, the access network is gradually expanded to match the demand and bandwidth requirements (see Figure 6).

## 8 Migrating to Public Ethernet

Public Ethernet represents a paradigm shift for existing ATM-centric access providers. The migration to Ethernet may be addressed in different ways, depending on the existing architecture and migration plans. In general, Ethernet technology can be deployed either as an access technology or as a transport technology. Today, Ethernet is commonly used to upgrade ATM-centric access solutions to interface with an Ethernet-based transport network,

such as an Ethernet metropolitan network, because of the advantages in cost efficiency and bandwidth capacity offered by the technology.

Public Ethernet is made up of the elements needed to create true Ethernet-based solutions for both the access and the transport components of the broadband network. These solutions may be integrated to tailor the migration path towards Ethernet to the needs of the individual network provider.

Although more and more providers are migrating to pure Ethernet transport solutions, legacy transport technologies such as ATM, SDH or PDH will continue to exist in the foreseeable future.

As an example, described in Figure 7, the Ethernet over ATM solution uses a gateway to map between the VLANs of the Ethernet aggregation network and the PVCs of the regional ATM transport network. In this way, the traffic that was divided in different service VLANs within the access network is still segregated over the transport network, and may be connected to different service providers via the ATM network.

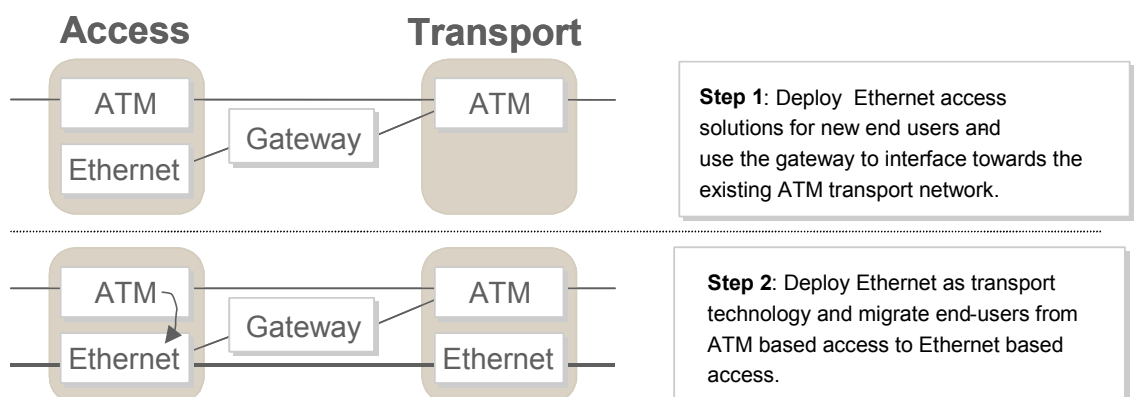

Figure 7. Ethernet migration scenario for ATM-centric providers

## 9 Managing Public Ethernet

Telecom management is one of the most important factors in creating a telecom-grade solution based on Ethernet technology. Traditionally, Ethernet networks have required very little provisioning and supervision when deployed in office environments or in homes. Adequate tools for operation, administration, maintenance and provisioning of the network and its users must, however, accompany the introduction of Ethernet into public networks.

For the most basic management of the access network component of Public Ethernet, an element manager tailored to the characteristics of the individual IP DSLAMs is required. In other words, it must handle the definition of access



network services, as well as the assignment of these services to end-users, even in situations with several access service providers using the same access network provider's offerings (unbundling).

Provisioning of services to end-users requires handling the settings in the Ethernet Access Nodes, such as the ADSL and ATM parameters, for each end-user. The element manager must also handle the installation and upgrade of access network nodes, as well as basic fault and performance management tasks for the access network. In a DSL scenario this includes, for example, functionality for local loop testing. To ensure smooth integration with existing management systems, the element manager must offer northbound management interfaces based on industry standards such as Common Object Request Broker Architecture (CORBA).

The element manager for the access nodes may be complemented by additional management tools, such as element managers for aggregation and transport network. Another tool is an end-to-end Ethernet connection management system, for managing virtual layer-2 Ethernet connections end-to-end. Further to this, there may be a need to manage advanced CPEs via a configuration server.

As opposed to traditional LAN Ethernet, a Public Ethernet network architecture includes also advanced tools to manage numerous access nodes and different types of services in order to provide telecom-grade performance.

## 10 True multi-service broadband access solution

The future of broadband access will create a number of challenges for service providers. The networks must provide existing services at a lower cost and simultaneously support many new types of revenue-generating applications, demanding high bandwidth and real-time traffic handling.

Ethernet is the superior technology choice for broadband access networks, thanks to its scalability, efficiency, low cost and ease of deployment. Public Ethernet allows providers to move from legacy ATM access networks to Ethernet-based access, minimizing investment and reusing their existing infrastructure in the future.

## 11 Abbreviations

AAA	Authentication, Authorization, and Accounting
ADSL	Asymmetric Digital Subscriber Line

ATM	Asynchronous Transfer Mode
BRAS	Broadband Remote Access Server
CORBA	Common Object Request Broker Architecture
CPE	Customer Premises Equipment
DSL	Digital Subscriber Line
IEEE	Institute of Electrical and Electronics Engineers
IETF	The Internet Engineering Task Force
IP	Internet Protocol
IP DSLAM	IP Digital Subscriber Line Access Multiplexor
ITU-T	International Telecommunication Union – Telecommunication Standardization Sector
LAN	Local Area Network
MAC	Media Access Control
MPLS	Multi Protocol Label Switching
NT	Network Terminal
PDH	Plesiochronous Digital Hierarchy
PPP	Point-to-Point Protocol
PVC	Permanent Virtual Connection
QoS	Quality of Service
SDH	Synchronous Digital Hierarchy
VLAN	Virtual Local Area Network
VPN	Virtual Private Network