

Chapter 3

METAL-PLATE LENS ANTENNAS

Paul Wade N1BWT © 1994,1998

Introduction

For portable microwave operation, particularly if backpacking is necessary, dishes or large horns may be heavy and bulky to carry. A metal-plate lens antenna is an attractive alternative. Placed in front of a modest-sized horn, the lens provides some additional gain, much like eyeglasses on a near-sighted person. The lens antennas I have built and tested are cheap and easy to construct, light in weight, and non-critical to adjust. The **HDL_ANT** computer program makes designing them easy as well.

There are other forms of microwave lenses — for instance, dielectric lenses and fresnel lenses — but the metal-plate lens is probably the easiest to build and lightest to carry, so it is the only type which will be described here.

The metal-lens antenna is constructed of a series of thin metal plates with air between them—the curvature of the edges of the plates forms the lens, and the space between the plates forms a series of waveguides. Fortunately, we can get air in a solid form to make construction easier — Styrofoam™ looks just like air to RF waves, and keeps the metal plates accurately spaced. We use aluminum foil for the plates, attaching it to the Styrofoam with spray adhesive, and shaping the curvature with an X-Acto™ knife on a compass. Designs are limited to those using circles, to ease construction.

Background

These metal-plate lenses were originally described by KB1VC and me at the 1992 Eastern VHF/UHF Conference¹ for 10 GHz; there is no good reason to limit them to that band. The need for more gain had become apparent to us during the 1991 10 Ghz contest. We were atop Burke Mountain in Vermont, on a day as clear as the tourist brochures. We could see Mt. Greylock in Massachusetts where KH6CP was located, but it was too far to work with the horn antennas on our Gunnplexers. After K1LPS humped his two-foot dish up the fire tower, we knew that a large dish wasn't the best answer for portable work.

Later, we found an article in VHF Communications on lens antennas by Angel Vilaseca, HB9SLV², which intrigued us. It described how to design a metal lens antenna but did not present expected gain or measured results.

We then searched through the references to try to understand how these antennas worked, and finally discovered that the best work was done before we were born, by Kock³. This paper made it clear how the metal lens antenna worked, and, more importantly, that it did work!

Lens Basics

The metal plate lens works, in principle, like any other lens. A similar optical lens⁴ would take a broad beam of light and shape it, by refraction, into a narrower beam. Refraction occurs at the interface of two materials in which light travels at different speeds, changing the direction of travel of the beam of light. If the beam is formed of many rays of light, each one may be bent; the ones at the edge of the beam bend more so they end up parallel to the center rays which are hardly bent at all. For this to work, each ray must take exactly the same time to travel from its source, at the focal point of the lens, to its destination. Since light travels more slowly in glass, a lens is thicker at the middle, to slow down the rays with a shorter path, and thinner at the edges, to allow the rays with longer paths to catch up. See Figure 3-1. The curvature of the lens to form the beam exactly is an ellipse; however, for small bending angles, a circle is almost identical to an ellipse, and nearly all optical lenses are ground with spherical curves.

Since light and RF are both electromagnetic waves, we could use glass or any other dielectric to make a lens for 10 GHz as well. A recent article⁵ described a dielectric lens using epoxy resin. However, for larger sizes this quickly becomes less attractive, and most dielectrics are rather lossy at 10 GHz. Low-loss materials are available but are costly and relatively heavy and difficult to shape.

Metal Plate Lens

Since electromagnetic waves travel at different speeds in waveguide and in free space, why not use waveguides of different lengths to form a lens? This has been done, and is known as an “eggcrate” lens⁶. However, it is easier to make a group of parallel plates which form wide parallel waveguides, and simply shape the input and output edges of these waveguides to change path lengths and form the lens surface. This differs from an optical lens in that the **phase** of the electromagnetic wave travels *faster* in a waveguide than in free space. (*We will not attempt to explain this seeming magic here, only refer you to "phase velocity" in any good book on microwaves. Rest assured that no laws of physics are being violated.*) Thus, the curvature of the metal lens antenna is the opposite of an equivalent optical or dielectric lens — in this case, concave instead of convex. We can still get away with using circular curvatures instead of ellipses as long as we aren't trying to bend the rays too sharply. This is why we feed the lens with a small horn, which does part of the beam forming; see Figure 3-2. Of course, if we want both horizontal and vertical beam shaping, we need a spherical shape, so we must shape the surface described by the edges of the metal plates into a sphere; see Figure 3-3.

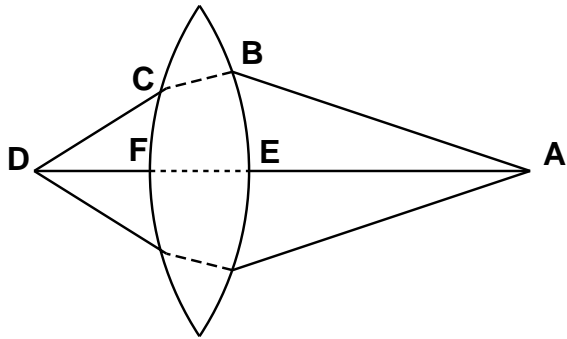

Travel time along AEFD equals travel time along ABCD.

Figure 3-1

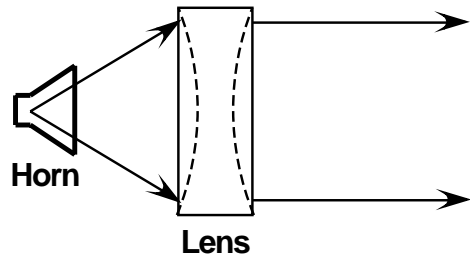

Horn Feeding Lens Antenna

Figure 3-2

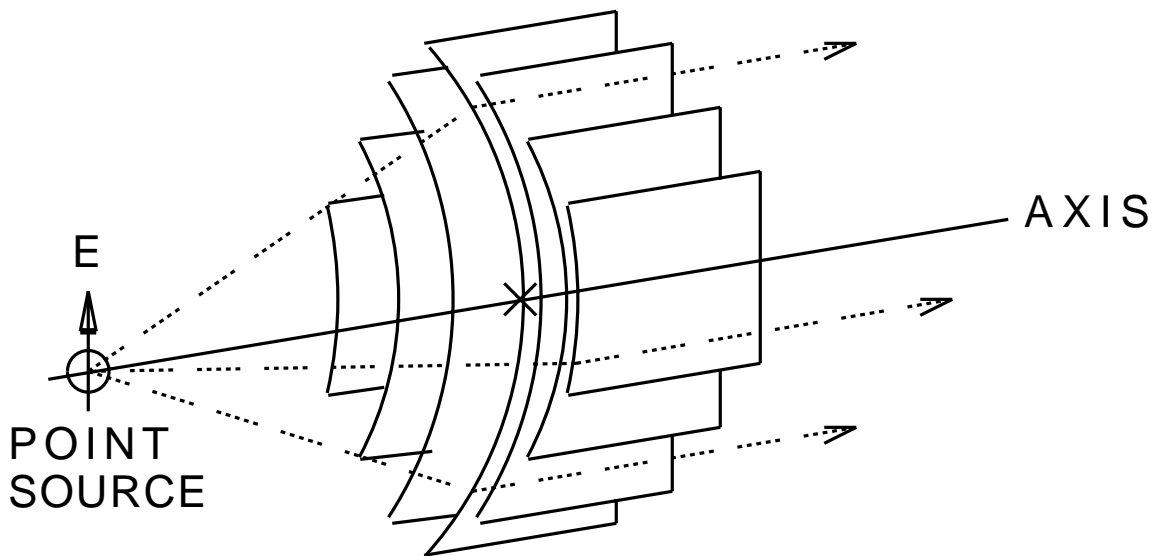

Figure 3-3. Metal Plate Lens Sketch

Lens Design

While the **HDL_ANT** program removes the drudgery from lens design and makes it available to amateurs, a general description of lens design might aid in understanding what is happening and what the computer is telling you.

First, some design objectives are needed: how big a lens is desired, and what are the dimensions of the horn feeding it? Gain is determined by aperture area (proportional to the diameter squared for dishes, horns, and lenses). A good rule of thumb is that doubling the aperture diameter will increase the gain by 6 dB, since the area of the aperture quadruples. For instance, an 8 inch lens in front of a four inch horn would add 6 dB to the gain of the horn, and a 16 inch lens would add 12 db. So modest gain improvements take modest sizes, but really big gain requires huge antennas, no matter what kind. However, a 6 dB increase in gain will double the range of a system over a line-of-sight path.

The horn dimensions may be determined by availability, or you may have the design freedom to build the horn as well. The beam width of the horn (usually smaller than the physical flare angle of the horn) is used to determine the focal length of the lens. Kraus⁷ gives the following approximations for 3 dB beam width in degrees and dB gain over a dipole:

$$E_{plane} = \frac{56}{A_e \lambda} \text{ degrees}$$

$$H_{plane} = \frac{67}{A_h \lambda} \text{ degrees}$$

and for gain

$$G \cong 10 \log_{10}(4.5 A_e \lambda A_h \lambda) \text{ dB over dipole}$$

where $A_e \lambda$ is the aperture dimension in wavelengths in the E-plane and $A_h \lambda$ is the aperture in wavelengths dimension in the H-plane.

These approximations are accurate enough to begin designing. From the beam width and desired lens aperture, finding the focal length f is a matter of geometry:

$$f = \frac{\text{Lens_diameter}}{2 \tan\left(\frac{W_{Eplane}}{2}\right)}$$

The final, and most critical, dimension is the spacing of the metal plates. The blue Styrofoam sheets sold as insulation have excellent thickness uniformity, and 3/4 inch is

pretty near optimum for 10 GHz, but the actual dimension should be measured carefully. The thickness determines the index of refraction:

$$\text{Index} = \sqrt{1 - \left(\frac{\lambda}{2 \cdot \text{spacing}} \right)^2}$$

which is the ratio of the wavelength in the lens to the wavelength in free space.

Next is calculation of the lens curvature. The optimum curvature is an ellipse, but we know that spherical lenses have been used for optics since Galileo, so a circle is a usable approximation. We can show that the circle is an excellent fit if the focal length is more than twice the lens diameter; photographers will recognize this as an $f/2$ lens. This suggests that the feed horn have a beam width of no more than 28 degrees, or a horn aperture of at least 2 wavelengths.

The radius of curvature \mathbf{R} of the two lens surfaces is calculated from the lensmaker's formula⁴:

$$\frac{1}{f} = (n - 1) \left(\frac{1}{R_1} - \frac{1}{R_2} \right)$$

where a negative radius is a concave surface. For the single-curved surface in Figure 3-4, one radius is set to infinity. All combinations of \mathbf{R}_1 and \mathbf{R}_2 which satisfy the formula are equivalent, as shown in Figure 3-5; the computer program calculates the single-curved lens and the symmetrical double-curved solutions shown in Figure 3-6. The radius of curvature as calculated above is for the surface, and thus the central plate, which has the full curvature. The rest of the plates must be successively wider and have smaller radii so that the edges of all the plates form a spherical lens surface. This is more geometry, and the program does the calculations for each plate.

The final calculation involves the phase-centers of the horn, so that the lens-to-horn distance matches the focal length. This is a difficult calculation⁸ involving calculation of Fresnel sines and cosines⁹; KB1VC deserves credit for the programming. Without a computer, you would use trial-and-error looking for best gain. What the calculations will show is that many horns, particularly the "optimum" designs, have much different phase centers in the E and H planes. The program offers to make a crude compensation for this, but if possible, the H-plane aperture of the horn should be adjusted slightly to match the phase centers. A few trial runs of the program should enable you to find a good combination. If you already have a horn, either try the compensation, or just go with the E-plane phase center.

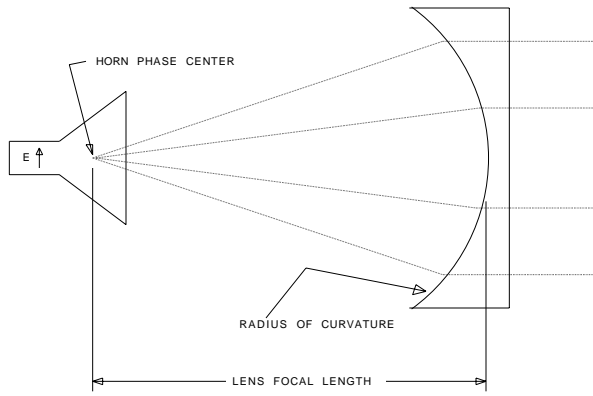

METAL LENS ANTENNA - SINGLE CURVE
 Figure 3-4
 N1BWT & KB1VC

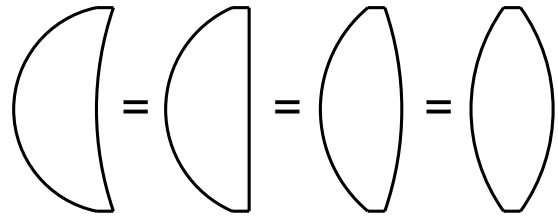

EQUIVALENT OPTICAL LENSES

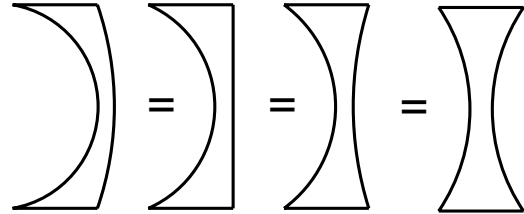

EQUIVALENT METAL LENS ANTENNAS

All have the same focal length

Figure 3-5

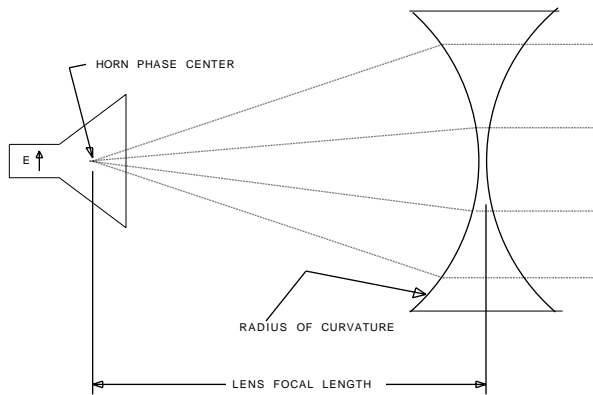

METAL LENS ANTENNA - DOUBLE CURVE
 Figure 3-6
 N1BWT & KB1VC

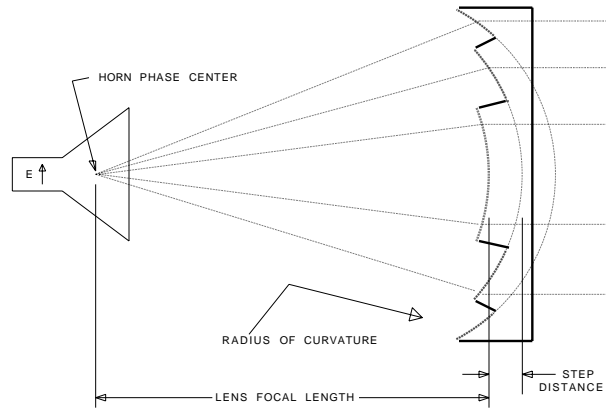

METAL LENS ANTENNA - ZONED TO REDUCE THICKNESS
 Figure 3-7
 N1BWT & KB1VC

For very large lenses, the size may be reduced by stepping the width of the plates into zones which keep transmission in phase, as shown in Figure 3-7. The program will suggest a step dimension, if it is useful. At 10 GHz, a step is useful only for lenses larger than 2 feet in diameter.

Construction

Construction is straightforward, using metal plates of aluminum foil spaced by Styrofoam), as suggested by HB9SLV². A 2 foot by 8 foot sheet of blue Styrofoam, 3/4 inch thickness, is less than five dollars at the local lumberyard, and will make several antennas. The aluminum foil is attached to the foam using artist's spray adhesive, available at art supply stores. Spray both surfaces lightly, let them dry for a minute or two, then spread the foil smoothly on the foam. If the adhesive melts the foam, you are using too much.

Next mark the outline of a rectangle for each metal plate on the foil — these will be used later to cut the foam and line up the plates, so they should all be the same size. Then mark the center of each curve and measure off the radius to the center of the circle. Using a compass with an X-Acto knife attached, place the point at the center of the circle and cut the curve through the foil into the foam. When all the curves are cut, peel off the unwanted foil, leaving the lens plates. Then cut up the rectangles with a razor blade and stack the blocks into a lens (you did number them!); each rectangle should have foil on one side. If it looks good, glue them up two at a time. The final antenna will be a block of foam —there is no need to shape the foam to the lens curve. Shrink-wrapping it with thin plastic would be nice weatherproofing. Figure 3-8 is a photo showing a single lens plate on foam and a complete 300 mm. lens for 10 GHz.

Some hints

Sharp blades really help, and permanent markers don't smear. If the foam is cut halfway through, it will snap cleanly on the line.

Adjustment

First, a metal-lens antenna only works in the E-plane. This is parallel to the elements of a dipole or Yagi antenna, but perpendicular to the wide dimension of a waveguide. The plates **must** be perpendicular to the wide dimension to provide gain.

The horn should point through the center of the lens, but the focus is not as critical as a dish. Aiming is done by pointing the feed horn; the lens focuses the beam more tightly but does not change beam direction. Tilting the lens will *not* steer the beam — if you don't believe this, take an optical lens, like a magnifying glass, focus it on something, and tilt it.

Figure 3-8



We found that the best gain was with the horn slightly closer to the lens than calculated, probably because of edge effects. Making the size of the plates slightly larger than calculated would probably eliminate this effect and make the gain a bit higher; since a wavelength at 10 GHz is about an inch, an inch or two oversize is plenty.

One other interesting effect was found with Gunnplexers: since the transmitter is also the receive local oscillator, reflected power from the lens adds to the LO power, or subtracts when out-of-phase. This makes the received signal strength vary every half-inch as the lens-to-horn distance is moved, with very little change at the other station. So adjust the spacing for best received signal. Of course, this effect does not exist on a system with low LO radiation.

Computer Program

The lens section of the **HDL_ANT** calculates the dimensions for the plates of a lens. Since all curves are circles that are easily drawn with a compass, templates are not generated. The basic input data is entered interactively, then results presented in tabular form. If you like the results, they may be saved to a file for printing or further processing; if not, try another run with new data.

All dimensions are in millimeters. There are two reasons for this: the first is that odd fractions lead to errors in measurement, and the second is that one millimeter is a good tolerance for 10 GHz lens dimensions. If all measurements are made to the nearest whole millimeter, good results can be expected. The only exception is the plate spacing, and that is accurately controlled by the foam thickness.

Results

We have constructed and tested three metal-plate lens antennas to date: a 150 mm. single-curved version, and 150 mm. and 300 mm. double-curved versions. Figure 3-9 shows the 300mm. lens fed by a Gunnplexer WBFM system. All the lenses were designed to be fed with the standard Gunnplexer horn, which has well matched phase centers, whether by design or by accident. Gain measurements on an antenna range, as described in Chapter 9, are shown in Table 3-1. The lenses perform with about 50% efficiency if we consider them as having a round aperture; the corners do not contribute significantly, but we made them square for convenient fabrication and mounting.

Antenna	Focal distance	Gain	Efficiency
Gunnplexer horn		17.5 dBi	57%
horn + 150mm lens	~8 inches	20.9 dBi	45%
horn + 300mm lens	~21 inches	27.4 dBi	50%

Table 3-1

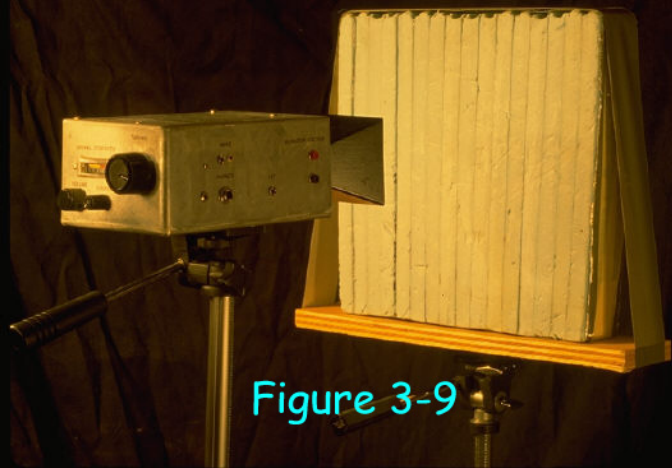

Figure 3-9

We also used the lenses during several contests during 1992 through 1997. The 300 mm. lens increased the range of our NBFM Gunnplexer transceivers by approximately 50%, to over 200 km., enabling contacts over new paths. The equipment was still highly portable due to the light weight of the lens.

Further Uses

The metal-lens antenna could be useful at other frequencies: for 5.76 GHz, a foam thickness of around 35 mm. would be good, and at 24 GHz, approximately 8 mm. thick foam might work, though it might be lossy at that frequency.

A lens could also be part of a more complex antenna system. For instance, a divergent lens could be used to provide better illumination for some of the very deep dishes that are sometimes available surplus. A book on optics⁴ will show how to change the focal points appropriately.

Lens Summary

We have demonstrated that metal-lens antennas may be easily designed and constructed using the **HDL_ANT** computer program, and that a book-sized lens, light and rugged enough for backpacking, provides adequate gain enhancement to double the range of a Gunnplexer system.

References

1. P. Wade, N1BWT, and M. Reilly, KB1VC, "Metal Lens Antennas for 10 GHz," *Proceedings of the 18th Eastern VHF/UHF Conference*, ARRL, May 1992, pp. 71-78.
2. Angel Vilaseca, HB9SLV, "Microwave Lens Antennas," *VHF Communications*, 3/90, pp. 179-189.
3. Winston E. Kock, "Metal-Lens Antennas," *Proc. I.R.E.*, Nov. 1946, p. 828-836.
4. Eugene Hecht, *Optics*, Addison-Wesley, 1987.
5. John M. Franke, WA4WDL, "Pour an Antenna for X-band," *73*, Feb. 1991.
6. Carlyle J. Sletten (W1YLV), *Reflector and Lens Antennas*, Aertech House, 1988.
7. John Kraus (W8JK), *Antennas*, McGraw Hill, 1956.
8. Eugen I. Muehldorf, "The Phase Center of Horn Antennas," reprinted in A. W. Love, *Electromagnetic Horn Antennas*, IEEE Press, 1976.

9. Milton Abramowitz and Irene A. Stegun, *Handbook of Mathematical Functions*, Dover, 1972.