

# IRF540, IRF541, IRF542, IRF543, RF1S540, RF1S540SM

25A and 28A, 80V and 100V, 0.077 and 0.100 Ohm,  
N-Channel Power MOSFETs

November 1997

## Features

- 25A and 28A, 80V and 100V
- $r_{DS(ON)} = 0.077\Omega$  and  $0.100\Omega$
- Single Pulse Avalanche Energy Rated
- Nanosecond Switching Speeds
- Linear Transfer Characteristics
- High Input Impedance
- Related Literature
  - TB334 "Guidelines for Soldering Surface Mount Components to PC Boards"

## Ordering Information

| PART NUMBER | PACKAGE  | BRAND     |
|-------------|----------|-----------|
| IRF540      | TO-220AB | IRF540    |
| IRF541      | TO-220AB | IRF541    |
| IRF542      | TO-220AB | IRF542    |
| IRF543      | TO-220AB | IRF543    |
| RF1S540     | TO-262AA | RF1S540   |
| RF1S540SM   | TO-263AB | RF1S540SM |

NOTE: When ordering, use the entire part number. Add the suffix 9A to obtain the TO-263AB variant in the tape and reel, i.e., RF1S540SM9A.

## Description

These are N-Channel enhancement mode silicon gate power field effect transistors. They are advanced power MOSFETs designed, tested, and guaranteed to withstand a specified level of energy in the breakdown avalanche mode of operation. All of these power MOSFETs are designed for applications such as switching regulators, switching converters, motor drivers, relay drivers, and drivers for high power bipolar switching transistors requiring high speed and low gate drive power. These types can be operated directly from integrated circuits.

Formerly developmental type TA17421.

## Symbol

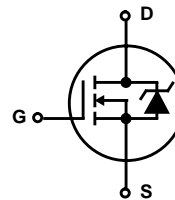

## Packaging

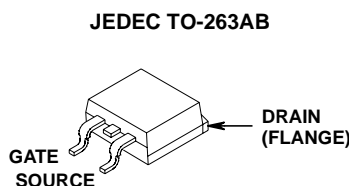
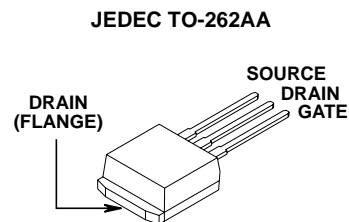
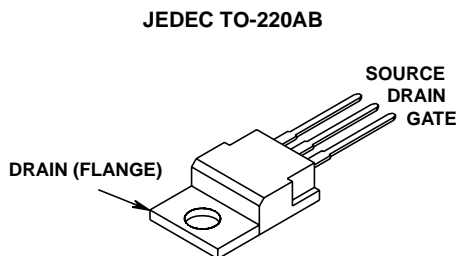

# IRF540, IRF541, IRF542, IRF543, RF1S540, RF1S540SM

## Absolute Maximum Ratings $T_C = 25^\circ\text{C}$ , Unless Otherwise Specified

|   | IRF540, RF1S540, RF1S540SM | IRF541     | IRF542     | IRF543     | UNITS      |                     |
|---|----------------------------|------------|------------|------------|------------|---------------------|
| Drain to Source Breakdown Voltage (Note 1) . . . . .              | $V_{DS}$                   | 100        | 80         | 100        | 80         | V                   |
| Drain to Gate Voltage ( $R_{GS} = 20k\Omega$ ) (Note 1) . . . . . | $V_{DGR}$                  | 100        | 80         | 100        | 80         | V                   |
| Continuous Drain Current . . . . .                                | $I_D$                      | 28         | 28         | 25         | 25         | A                   |
| $T_C = 100^\circ\text{C}$ . . . . .                               | $I_D$                      | 20         | 20         | 17         | 17         | A                   |
| Pulsed Drain Current (Note 3) . . . . .                           | $I_{DM}$                   | 110        | 110        | 100        | 100        | A                   |
| Gate to Source Voltage . . . . .                                  | $V_{GS}$                   | $\pm 20$   | $\pm 20$   | $\pm 20$   | $\pm 20$   | V                   |
| Maximum Power Dissipation . . . . .                               | $P_D$                      | 150        | 150        | 150        | 150        | W                   |
| Dissipation Derating Factor . . . . .                             |                            | 1          | 1          | 1          | 1          | W/ $^\circ\text{C}$ |
| Single Pulse Avalanche Energy Rating (Note 4) . . . . .           | $E_{AS}$                   | 230        | 230        | 230        | 230        | mJ                  |
| Operating and Storage Temperature . . . . .                       | $T_J, T_{STG}$             | -55 to 175 | -55 to 175 | -55 to 175 | -55 to 175 | $^\circ\text{C}$    |
| Maximum Temperature for Soldering                                 |                            |            |            |            |            |                     |
| Leads at 0.063in (1.6mm) from Case for 10s . . . . .              | $T_L$                      | 300        | 300        | 300        | 300        | $^\circ\text{C}$    |
| Package Body for 10s, See Techbrief 334 . . . . .                 | $T_{pkg}$                  | 260        | 260        | 260        | 260        | $^\circ\text{C}$    |

CAUTION: Stresses above those listed in "Absolute Maximum Ratings" may cause permanent damage to the device. This is a stress only rating and operation of the device at these or any other conditions above those indicated in the operational sections of this specification is not implied.

NOTE:

- $T_J = 25^\circ\text{C}$  to  $T_J = 150^\circ\text{C}$ .

## Electrical Specifications $T_C = 25^\circ\text{C}$ , Unless Otherwise Specified

| PARAMETER   | SYMBOL       | TEST CONDITIONS   | MIN   | TYP   | MAX       | UNITS         |
|---|--------------|---|---|-------|-----------|---------------|
| Drain to Source Breakdown Voltage<br>IRF540, IRF542,<br>RF1S540, RF1S540SM      | $BV_{DSS}$   | $I_D = 250\mu\text{A}, V_{GS} = 0\text{V}$ (Figure 10)  | 100   | -     | -         | V             |
| IRF541, IRF543  |              |   | 80  | -     | -         | V             |
| Gate to Threshold Voltage   | $V_{GS(TH)}$ | $V_{GS} = V_{DS}, I_D = 250\mu\text{A}$   | 2   | -     | 4         | V             |
| Zero Gate Voltage Drain Current   | $I_{DSS}$    | $V_{DS} = \text{Rated } BV_{DSS}, V_{GS} = 0\text{V}$   | -   | -     | 25        | $\mu\text{A}$ |
|   |              | $V_{DS} = 0.8 \times \text{Rated } BV_{DSS}, V_{GS} = 0\text{V}$<br>$T_J = 150^\circ\text{C}$   | -   | -     | 250       | $\mu\text{A}$ |
| On-State Drain Current (Note 2)<br>IRF540, IRF541,<br>RF1S540, RF1S540SM        | $I_{D(ON)}$  | $V_{DS} > I_{D(ON)} \times r_{DS(ON)} \text{ MAX}, V_{GS} = 10\text{V}$<br>(Figure 7)   | 28  | -     | -         | A             |
| IRF542, IRF543  |              |   | 25  | -     | -         | A             |
| Gate to Source Leakage Current  | $I_{GSS}$    | $V_{GS} = \pm 20\text{V}$   | -   | -     | $\pm 100$ | nA            |
| Drain to Source On Resistance (Note 2)<br>IRF540, IRF541,<br>RF1S540, RF1S540SM | $r_{DS(ON)}$ | $I_D = 17\text{A}, V_{GS} = 10\text{V}$ (Figures 8, 9)  | -   | 0.060 | 0.077     | $\Omega$      |
| IRF542, IRF543  |              |   | -   | 0.080 | 0.100     | $\Omega$      |
| Forward Transconductance (Note 2)   | $g_{fs}$     | $V_{DS} \geq 50\text{V}, I_D = 17\text{A}$ (Figure 12)  | 8.7   | 13    | -         | S             |
| Turn-On Delay Time  | $t_{d(ON)}$  | $V_{DD} = 50\text{V}, I_D \approx 28\text{A}, R_G \approx 9.1\Omega, R_L = 1.7\Omega$<br>(Figures 17, 18) MOSFET Switching Times are<br>Essentially Independent of Operating<br>Temperature | -   | 15    | 23        | ns            |
| Rise Time   | $t_r$        |   | -   | 70    | 110       | ns            |
| Turn-Off Delay Time   | $t_{d(OFF)}$ |   | -   | 40    | 60        | ns            |
| Fall Time   | $t_f$        |   | -   | 50    | 75        | ns            |
| Total Gate Charge<br>(Gate to Source + Gate to Drain)                           | $Q_{g(TOT)}$ |   | $V_{GS} = 10\text{V}, I_D = 28\text{A}, V_{DS} = 0.8 \times \text{Rated } BV_{DSS}, I_{g(REF)} = 1.5\text{mA}$ (Figures 14, 19, 20)<br>Gate Charge is Essentially Independent of Op-<br>erating Temperature | -     | 38        | 59            |
| Gate to Source Charge   | $Q_{gs}$     |   | -   | 8     | -         | nC            |
| Gate to Drain "Miller" Charge   | $Q_{gd}$     |   | -   | 21    | -         | nC            |

## IRF540, IRF541, IRF542, IRF543, RF1S540, RF1S540SM

### Electrical Specifications $T_C = 25^\circ\text{C}$ , Unless Otherwise Specified (Continued)

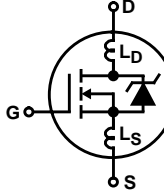
| PARAMETER                              | SYMBOL          | TEST CONDITIONS   |   | MIN | TYP  | MAX | UNITS              |
|--|-----------------|---|---|-----|------|-----|--------------------|
| Input Capacitance                      | $C_{ISS}$       | $V_{DS} = 25\text{V}$ , $V_{GS} = 0\text{V}$ , $f = 1\text{MHz}$<br>(Figure 11) |   | -   | 1450 | -   | pF                 |
| Output Capacitance                     | $C_{OSS}$       |   |   | -   | 550  | -   | pF                 |
| Reverse Transfer Capacitance           | $C_{RSS}$       |   |   | -   | 100  | -   | pF                 |
| Internal Drain Inductance              | $L_D$           | Measured From the Contact Screw on Tab To Center of Die                         | Modified MOSFET Symbol Showing the Internal Devices Inductances<br> | -   | 3.5  | -   | nH                 |
|  |                 | Measured From the Drain Lead, 6mm (0.25in) from Package to Center of Die        |   | -   | 4.5  | -   | nH                 |
| Internal Source Inductance             | $L_S$           | Measured From the Source Lead, 6mm (0.25in) From Header to Source Bonding Pad   |   |     | -    | 7.5 | -                  |
| Thermal Resistance Junction to Case    | $R_{\theta JC}$ |   |   | -   | -    | 1   | $^\circ\text{C/W}$ |
| Thermal Resistance Junction to Ambient | $R_{\theta JA}$ | Free Air Operation  |   | -   | -    | 80  | $^\circ\text{C/W}$ |
|  | $R_{\theta JA}$ | RF1S540SM Mounted on FR-4 Board with Minimum Mounting Pad                       |   | -   | -    | 62  | $^\circ\text{C/W}$ |

### Source to Drain Diode Specifications

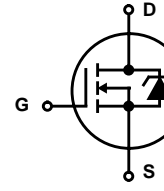
| PARAMETER                              | SYMBOL    | TEST CONDITIONS  |  | MIN  | TYP | MAX | UNITS         |
|--|-----------|--|--|------|-----|-----|---------------|
| Continuous Source to Drain Current     | $I_{SD}$  | Modified MOSFET Symbol Showing the Integral Reverse P-N Junction Diode<br> |  | -    | -   | 28  | A             |
| Pulse Source to Drain Current (Note 3) | $I_{SDM}$ |  |  | -    | -   | 110 | A             |
| Source to Drain Diode Voltage (Note 2) | $V_{SD}$  | $T_J = 25^\circ\text{C}$ , $I_{SD} = 27\text{A}$ , $V_{GS} = 0\text{V}$ (Figure 13)  |  | -    | -   | 2.5 | V             |
| Reverse Recovery Time                  | $t_{rr}$  | $T_J = 25^\circ\text{C}$ , $I_{SD} = 28\text{A}$ , $dI_{SD}/dt = 100\text{A}/\mu\text{s}$  |  | 70   | 150 | 300 | ns            |
| Reverse Recovery Charge                | $Q_{RR}$  | $T_J = 25^\circ\text{C}$ , $I_{SD} = 28\text{A}$ , $dI_{SD}/dt = 100\text{A}/\mu\text{s}$  |  | 0.44 | 1.0 | 1.9 | $\mu\text{C}$ |

**NOTES:**

2. Pulse test: pulse width  $\leq 300\mu\text{s}$ , duty cycle  $\leq 2\%$ .
3. Repetitive rating: pulse width limited by maximum junction temperature. See Transient Thermal Impedance curve (Figure 3).
4.  $V_{DD} = 25\text{V}$ , starting  $T_J = 25^\circ\text{C}$ ,  $L = 440\mu\text{H}$ ,  $R_G = 25\Omega$ , peak  $I_{AS} = 28\text{A}$ . (Figures 15, 16).

# IRF540, IRF541, IRF542, IRF543, RF1S540, RF1S540SM

## Typical Performance Curves Unless Otherwise Specified

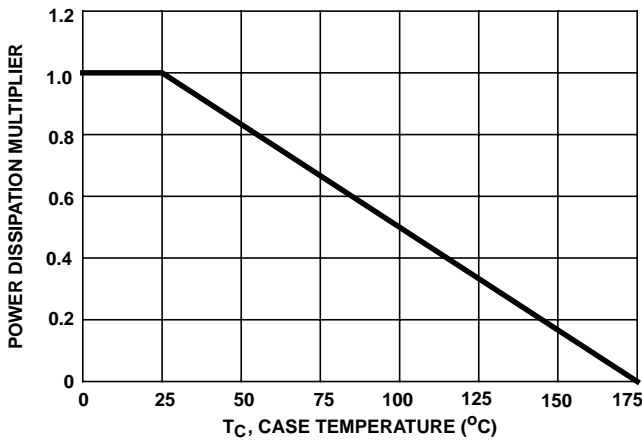

FIGURE 1. NORMALIZED POWER DISSIPATION vs CASE TEMPERATURE

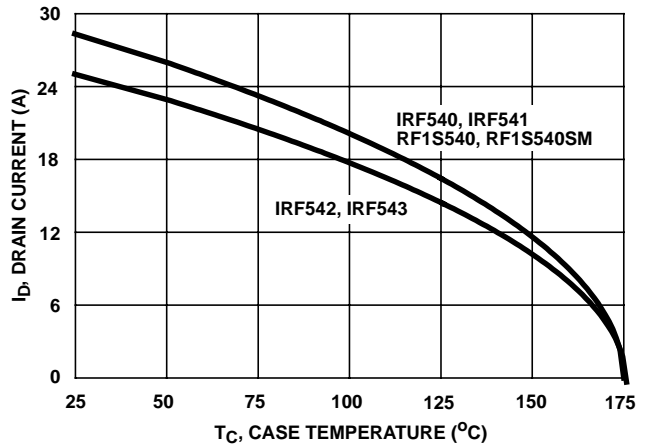

FIGURE 2. MAXIMUM CONTINUOUS DRAIN CURRENT vs CASE TEMPERATURE

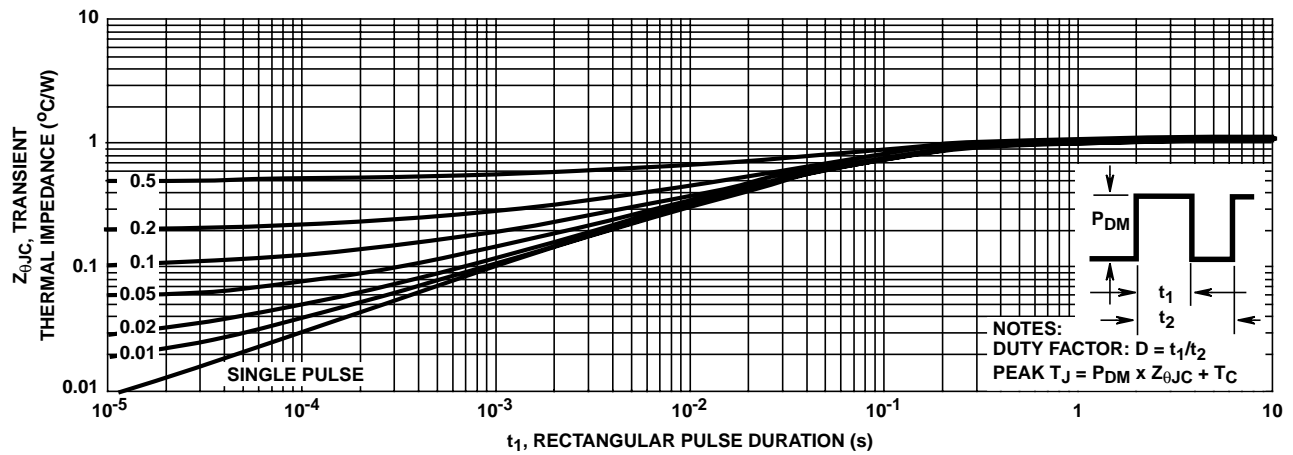

FIGURE 3. MAXIMUM TRANSIENT THERMAL IMPEDANCE

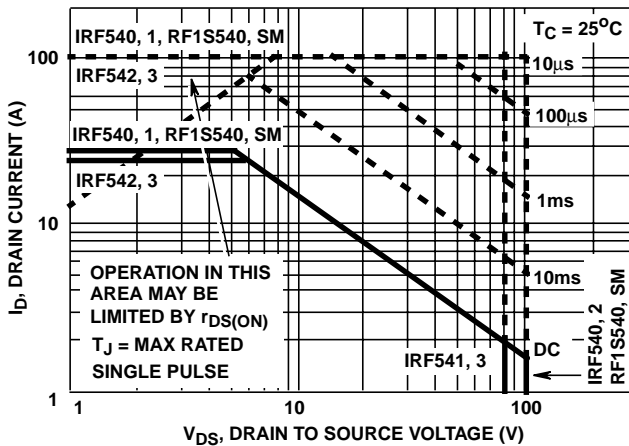

FIGURE 4. FORWARD BIAS SAFE OPERATING AREA

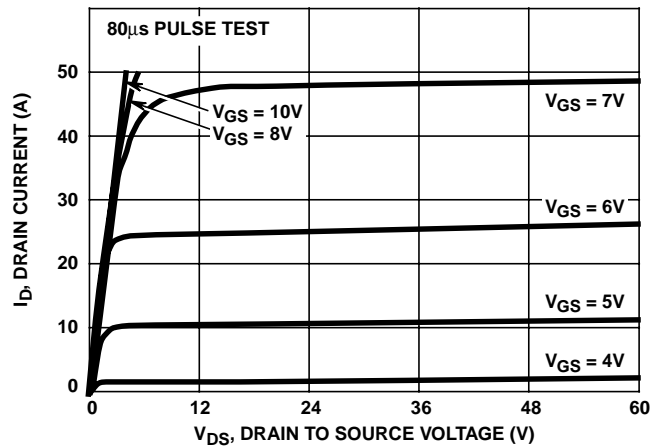

FIGURE 5. OUTPUT CHARACTERISTICS

Typical Performance Curves Unless Otherwise Specified (Continued)

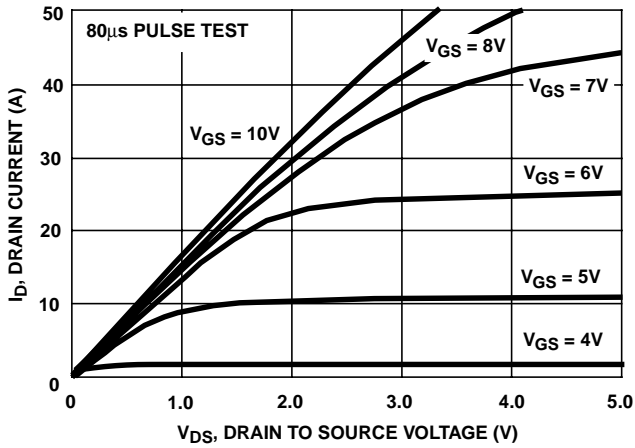

FIGURE 6. SATURATION CHARACTERISTICS

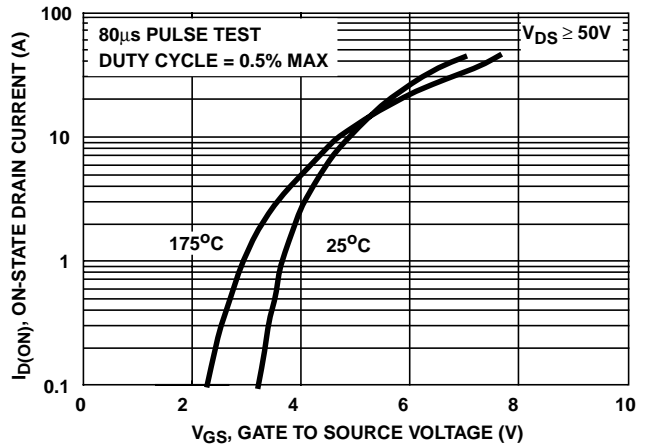

FIGURE 7. TRANSFER CHARACTERISTICS

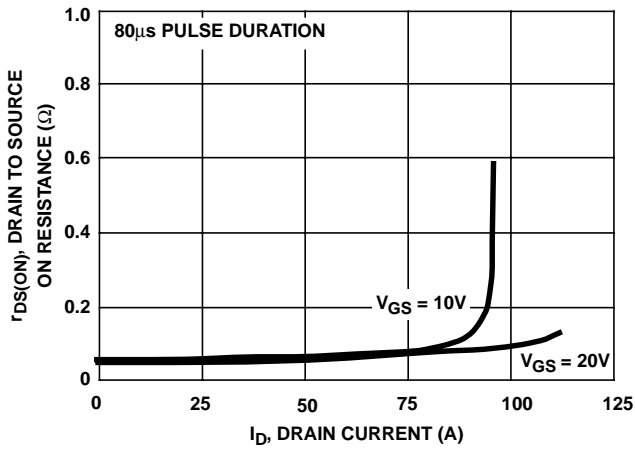

FIGURE 8. DRAIN TO SOURCE ON RESISTANCE vs GATE VOLTAGE AND DRAIN CURRENT

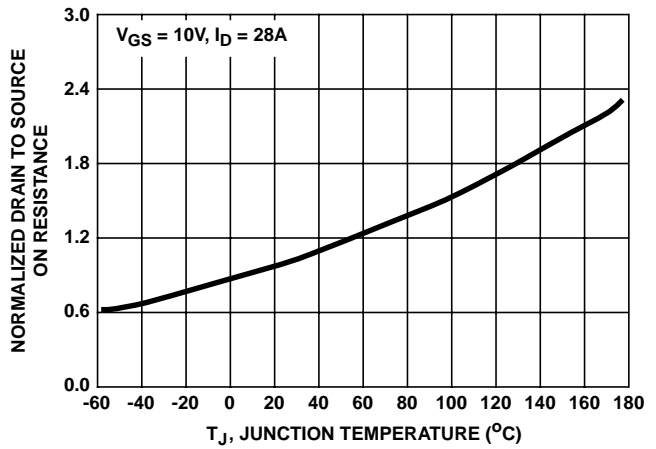

FIGURE 9. NORMALIZED DRAIN TO SOURCE ON RESISTANCE vs JUNCTION TEMPERATURE

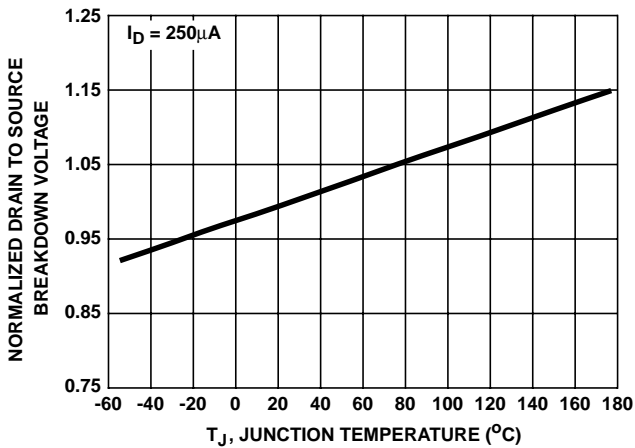

FIGURE 10. NORMALIZED DRAIN TO SOURCE BREAKDOWN VOLTAGE vs JUNCTION TEMPERATURE

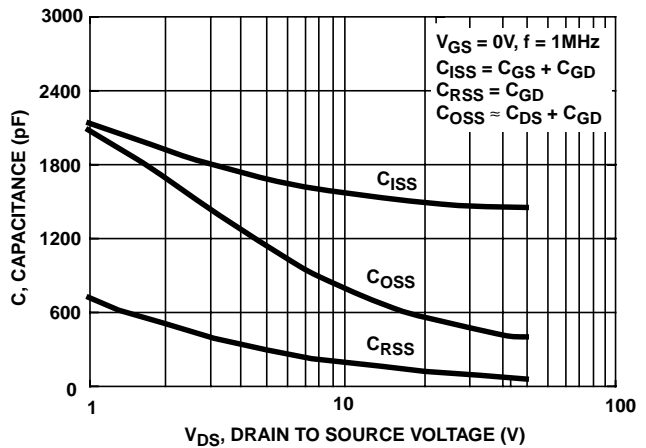

FIGURE 11. CAPACITANCE vs DRAIN TO SOURCE VOLTAGE

**Typical Performance Curves** Unless Otherwise Specified (Continued)

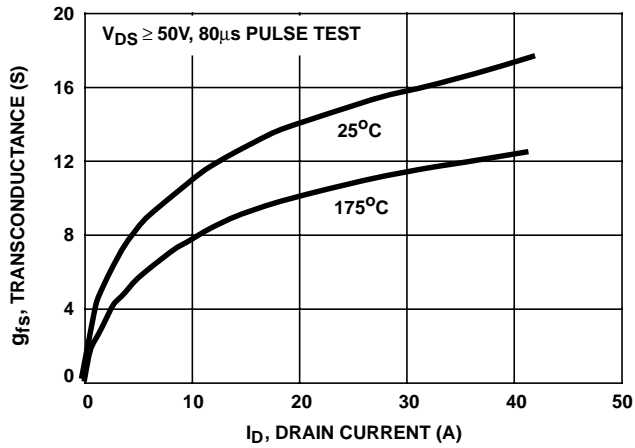

FIGURE 12. TRANSCONDUCTANCE vs DRAIN CURRENT

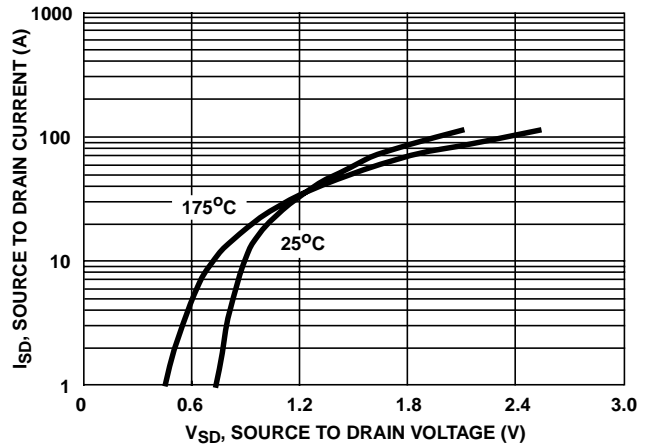

FIGURE 13. SOURCE TO DRAIN DIODE VOLTAGE

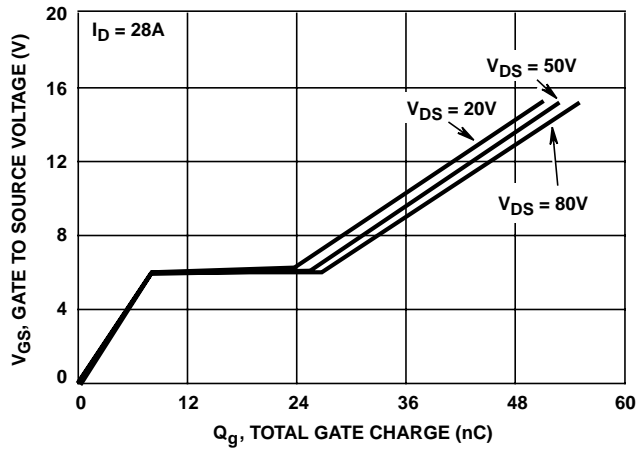

FIGURE 14. GATE TO SOURCE VOLTAGE vs GATE CHARGE

Test Circuits and Waveforms

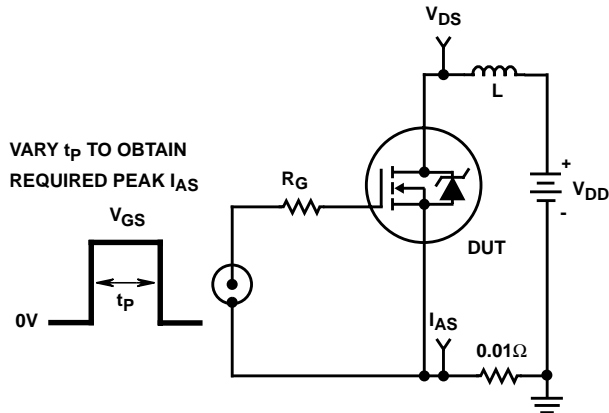

FIGURE 15. UNCLAMPED ENERGY TEST CIRCUIT

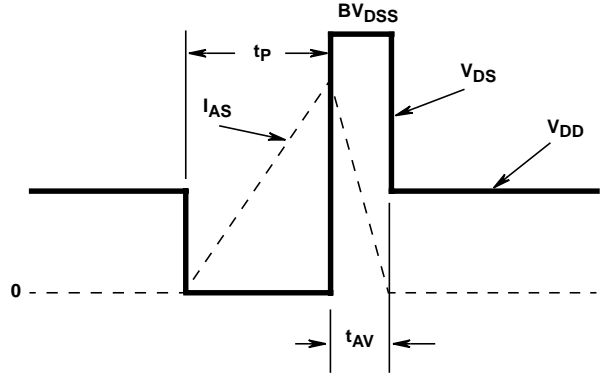

FIGURE 16. UNCLAMPED ENERGY WAVEFORMS

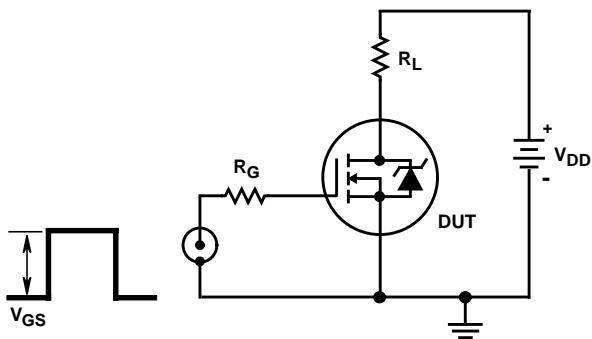

FIGURE 17. SWITCHING TIME TEST CIRCUIT

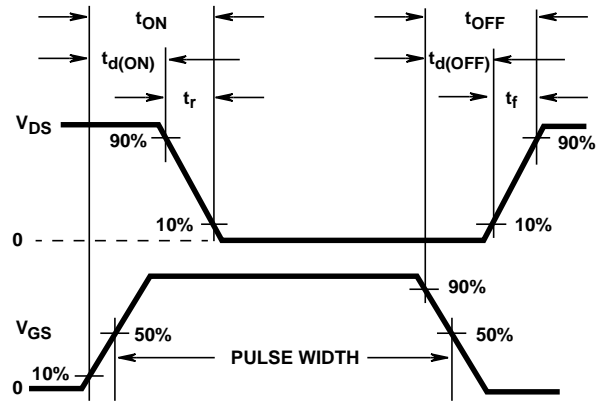

FIGURE 18. RESISTIVE SWITCHING WAVEFORMS

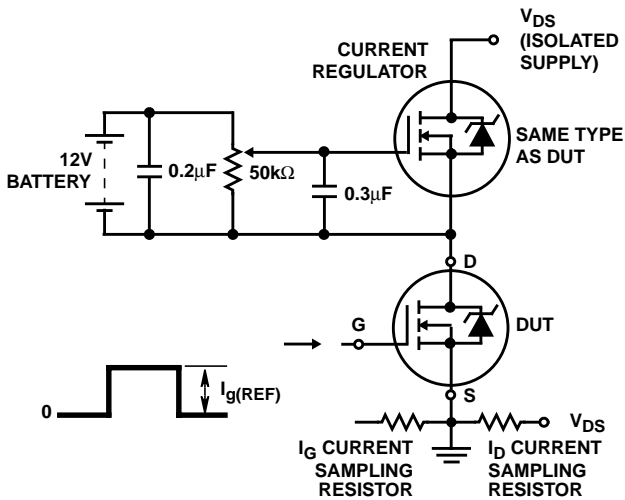

FIGURE 19. GATE CHARGE TEST CIRCUIT

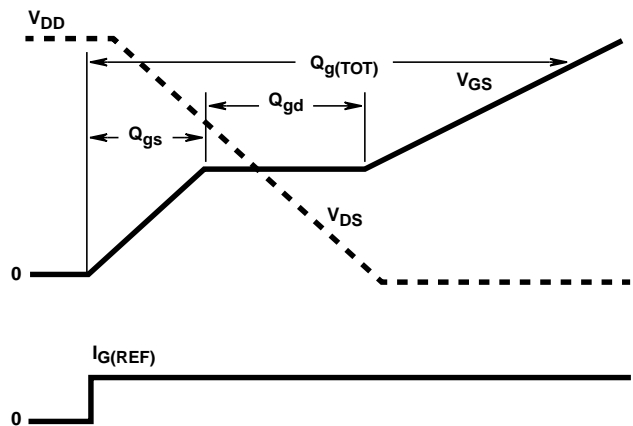

FIGURE 20. GATE CHARGE WAVEFORMS